



Infrastructure Master Plan 2024 2024/2025 - 2054/2055

VOLUME 3

uMkhomazi System; Upper uMzimkhulu System and Upper Mzintlava System



Infrastructure Development Division, uMngeni-uThukela Water

310 Burger Street, Pietermaritzburg, 3201, Republic of South Africa
P.O.Box 9, Pietermaritzburg, 3200, Republic of South Africa
Tel: +27 (33) 341 1111 / Fax: +27 (33) 341 1167 / Toll free: 0800 331 820
Email: info@umngeni.co.za / Web: www.umngeni-uthukela.co.za

To create value for our customers by providing water services at the right quality and quantity, within acceptable levels of reliability and affordability, to support sustainable economic development in KwaZulu-Natal.



For further information, please contact:

Planning Services
Infrastructure Development Division
Umgeni Water

P.O.Box 9, Pietermaritzburg, 3200
KwaZulu-Natal, South Africa

Tel: 033 341-1522

Fax: 033 341-1218

Email: info@umgeni.co.za

Web: www.umngeni-uthukela.co.za



UMNGENI-UTHUKELA WATER

INFRASTRUCTURE MASTER PLAN 2024

2024/2025 – 2054/2055

JUNE 2024

Prepared by:

Digitally signed by Vernon Perumal
DN: cn=Vernon Perumal, o=Umgeni
Water, ou=ID: Planning,
email=vernon.perumal@umgeni.co.
za, c=ZA
Date: 2024.06.25 11:29:01 +02'00'

Vernon Perumal *PrTechEng*

Planning Engineer

PS Sithole

Digitally signed by PS Sithole
DN: cn=PS Sithole, o=Umgeni-uThukela
Water, ou=Planning Services Department,
email=sandile.sithole@umgeni.co.za, c=ZA
Date: 2024.06.25 15:08:58 +02'00'

Sandile Sithole *PrSciNat*

Hydrologist

Approved by:

**Kevin
Meier**

Digitally signed by Kevin Meier
Date: 2024.06.25 15:44:55
+02'00'

Kevin Meier *PrEng*

Manager: Planning Services

Alan Kockott

Digitally signed by Alan Kockott
DN: cn=Alan Kockott, o=Umgeni-uThukela Water, ou=Engineering Services,
email=alan.kockott@umgeni.co.za, c=ZA
Date: 2024.06.27 08:23:38 +02'00'

Alan Kockott *PrEng*

Acting Executive: Infrastructure Development

PREFACE

This Infrastructure Master Plan 2024 describes:

- uMngeni-uThukela Water’s infrastructure plans for the financial period 2024/2025 – 2054/2055, and
- Infrastructure master plans for other areas outside of uMngeni-uThukela Water’s Operating Area but within KwaZulu-Natal.

It is a comprehensive technical report that provides information on current infrastructure and on future infrastructure development plans. This report replaces the last comprehensive Infrastructure Master Plan that was compiled in 2023.

The report is divided into **ten** volumes as per the organogram below.

Volume 1 includes the following sections and a description of each is provided below:

- **Section 2** describes the most recent changes and trends within the primary environmental dictates that influence development plans within the province.
- **Section 3** relates only to the uMngeni-uThukela Water Operational Areas and provides a review of historic water sales against past projections, as well as uMngeni-uThukela Water’s most recent water demand projections, compiled at the end of 2023.
- **Section 4** describes Water Demand Management initiatives that are being undertaken by the utility and the status of Water Demand Management Issues in KwaZulu-Natal.
- **Section 5**, which also relates to uMngeni-uThukela Water’s Operational Area, contains a high level review of the energy consumption used to produce the water volumes analysed in Section 3.
- **Section 6** provides an overview of the water resource regions and systems supplied within these regions.

The next eight volumes describe the current water resource situation and water supply infrastructure of the various systems in KwaZulu-Natal, including:

- **Volume 2 Section 7** uMngeni System.
- **Volume 3 Section 8** uMkhomazi System
Section 9 uMzimkhulu System
Section 10 Mzintlava System
- **Volume 4 Section 11** South Coast System
- **Volume 5 Section 12** North Coast System
- **Volume 6 Section 13** Upper uThukela System
- **Volume 7 Section 14** Buffalo System
- **Volume 8 Section 15** Middle uThukela System
Section 16 Mhlathuze System
- **Volume 9 Section 17** Umfolozi System
Section 18 uMkhuze / uPhongolo / Lake Sibiya System

Volume 10, Section 19 describes the wastewater works currently operated by uMngeni-uThukela Water (shown in pale brown in the adjacent figure) and provides plans for development of additional wastewater treatment facilities. The status of wastewater treatment in WSA’s that are not supplied by uMngeni-uThukela Water are also described in this section.

Infrastructure Master Plan 2024/2025

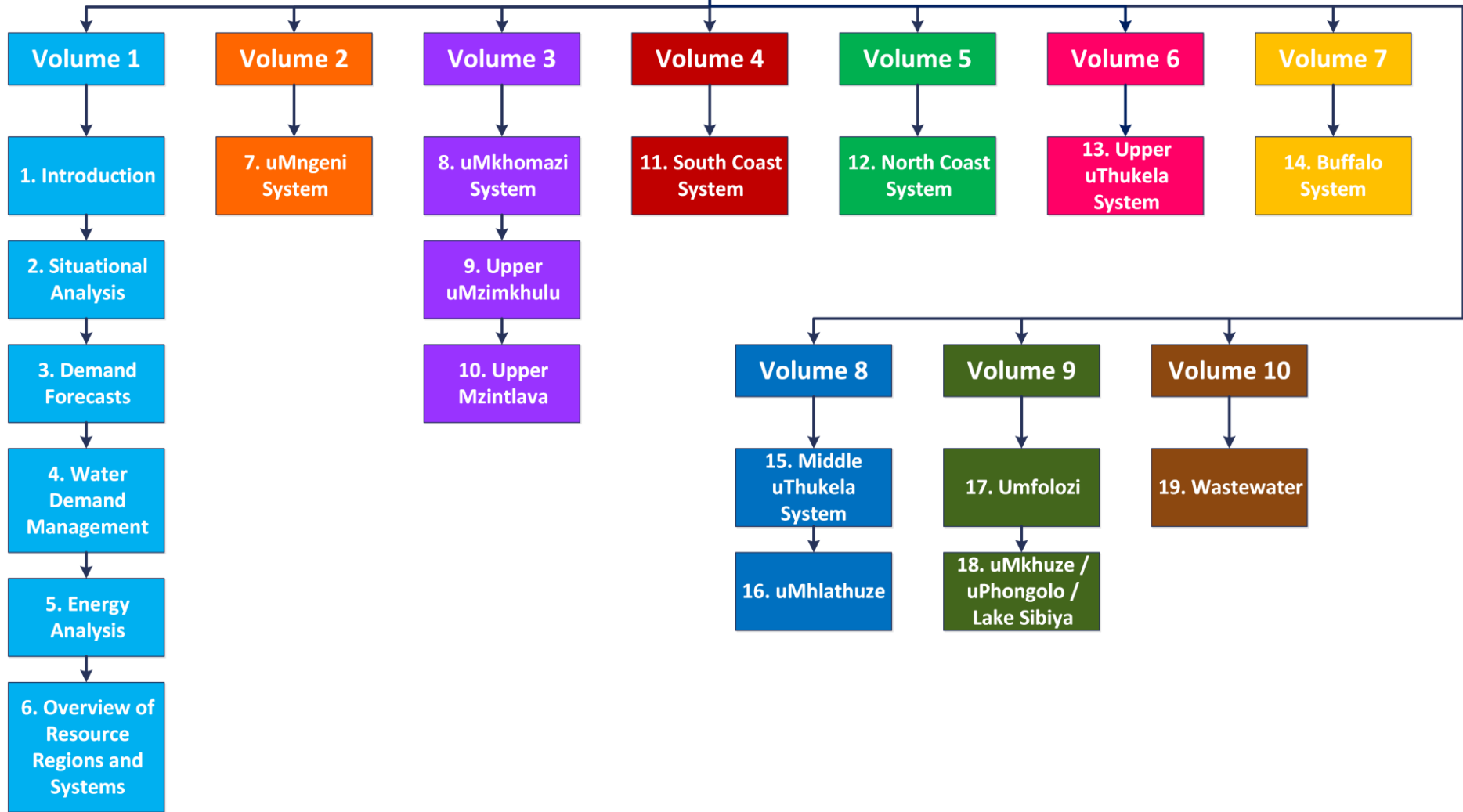

It is important to note that information presented in this report is in a summarised form and it is recommended that the reader refer to relevant planning reports if more detail is sought. Since the primary focus of this Infrastructure Master Plan is on bulk supply networks, the water resource infrastructure development plans are not discussed at length. The Department of Water and Sanitation (DWS), as the responsible authority, has undertaken the regional water resource development investigations. All of these investigations have been conducted in close collaboration with uMngeni-uThukela Water and other major stakeholders in order to ensure that integrated planning occurs. Details on these projects can be obtained directly from DWS, Directorate: Options Analysis (East).

The Infrastructure Master Plan is a dynamic and evolving document. Outputs from current planning studies, and comments received on this document will therefore be taken into account in the preparation of the next update.

TABLE OF CONTENTS

Table of Contents	ii
List of Figures	iii
List of Tables.....	iv
List of Acronyms	v
List of Units.....	viii
8. uMkhomazi System.....	1
8.1 Synopsis of uMkhomazi System	1
8.2 Water Resources of the uMkhomazi System	5
8.2.1 Description of the uMkhomazi System Water Resource Region	5
8.2.2 Reserve of the uMkhomazi River	5
8.2.3 Existing Infrastructure and Yields.....	5
8.2.4 Operating Rules.....	8
8.3 Supply Systems	8
8.3.1 Description of the Ixopo System	8
8.3.2 Status Quo and Limitations of the Ixopo System	11
8.4 Water Balance/Availability	14
8.5 Recommendations for the uMkhomazi System	15
8.5.1 System Components	15
8.5.2 Projects.....	16
9. Upper Mzimkhulu System.....	27
9.1 Synopsis of the Upper Mzimkhulu System	27
9.2 Water Resources of the Upper Mzimkhulu System	31
9.2.1 Description of the Upper Mzimkhulu System Water Resource Region	31
9.2.2 Reserve.....	32
9.2.3 Existing Water Resource Infrastructure and Yields.....	32
9.2.4 Operating Rules.....	33
9.3 Supply Systems	33
9.3.1 Description of the Upper Mzimkhulu System	33
9.3.2 Status Quo and Limitations of the Upper Mzimkhulu System	54
9.4 Water Balance/Availability	55
9.5 Recommendations for the Upper Mzimkhulu System	56
9.5.1 System Components	56
9.5.2 Long Term Recommendation.....	57
10. Upper Mzintlava System	60
10.1 Synopsis of the Upper Mzintlava System	60
10.2 Water Resources of the Upper Mzintlava System	63
10.2.1 Description of the Upper Mzintlava System Water Resource Regions.....	63
10.2.2 Reserve.....	70
10.2.3 Existing Water Resource Infrastructure	70
10.2.4 Operating Rules.....	77
10.3 Supply Systems	79
10.3.1 Description of the Upper Mzintlava System	79
10.3.2 Status Quo and Limitations of the Kokstad System	85
10.4 Water Balance/Availability	85
10.5 Recommendations for the Mzintlava System	87
10.5.1 System Components	87

LIST OF FIGURES

Figure 8.1	Schematic of the Ixopo System.	2
Figure 8.2	Location of the Ixopo System in the uMkhomazi Water Resource Region.	3
Figure 8.3	General layout of the Ixopo System.	4
Figure 8.4	Home Farm Dam.	6
Figure 8.5	Ixopo Water Treatment Plant.	9
Figure 8.6	Water Demand from Ixopo WTP.	12
Figure 8.7	Analysis of historical production at Ixopo WTP (November 2019 to October 2020).	13
Figure 8.8	Ixopo System Water Balance.	15
Figure 8.9	Proposed uMzimkhulu Bulk Water Supply Scheme.	17
Figure 8.10	Weir and Package Plant on the Luhane River.	20
Figure 8.11	Layout of the Weir and Package Plant.	21
Figure 8.12	Overall Layout of the HGDM RBWSS.	22
Figure 8.13	Layout of Stephen Dlamini Dam.	23
Figure 8.14	Stephen Dlamini WTP.	24
Figure 9.1	Schematic of the Upper uMzimkhulu River System.	28
Figure 9.2	General layout of the Upper uMzimkhulu System.	29
Figure 9.3	Network diagram of the Upper uMzimkhulu System.	30
Figure 9.4	Schematic of the Underberg System.	38
Figure 9.5	Pictorial view of the uMzimkhulu WTP.	40
Figure 9.6	Schematic of the uMzimkhulu System.	45
Figure 9.7	Pictorial View of the Ibisi WTP.	47
Figure 9.8	Schematic of the Ibisi BWSS.	52
Figure 10.1	General layout of the Upper Mzintlava System.	61
Figure 10.2	Schematic of the Upper Mzintlava River System.	62
Figure 10.3	Network chart of the Upper Mzintlava System.	63
Figure 10.4	Upper Mzintlava land cover (DEA and GTI 2018; MDB 2020; uMngeni-uThukela Water 2021).	66
Figure 10.5	Upper Mzintlava groundwater potential (MDB 2020; uMngeni-uThukela Water 2021; after DWA 1997 and WR2012).	70
Figure 10.6	General layout of water resource infrastructure supplying Kokstad.	72
Figure 10.7	Crystal Springs Dam (Nightjar Travel Guide South Africa 2017: website).	73
Figure 10.8	Kemptondale Dam, Kemptondale Quarry and Mzintlava Weir (Google Earth 2020: website).	76
Figure 10.9	Crystal Springs Dam annual operating rule curve (DWS, 2016).	78
Figure 10.10	Schematic of Kokstad BWSS.	84

LIST OF TABLES

Table 8.1	Characteristics of Home Farm Dam.....	7
Table 8.2	Existing Dams in the Ixopo Region.	7
Table 8.3	Pipeline details: Ixopo System.....	10
Table 8.4	Pump details: Ixopo System.	10
Table 8.5	Reservoir details: Ixopo System.	10
Table 8.6	Characteristics of the Ixopo WTP.	11
Table 8.7	Project information: uMzimkhulu Bulk Water Supply Scheme.....	18
Table 9.1	Upper uMzimkhulu Region Hydrological Characteristics (WR2012: Mvoti to uMzimkhulu Quat Info WMA 11 7Jul2015 spreadsheet).	32
Table 9.2	Characteristics of the Underberg WTP.....	35
Table 9.3	Pump Station Details: Underberg System, uMzimkhulu River (weir), Raw Water.....	37
Table 9.4	Pipeline Details: Underberg System, Raw Water Supply Pipelines.....	37
Table 9.5	Pipeline Details: Underberg Potable Supply Pipelines	39
Table 9.6	Reservoir Details: Underberg System.....	39
Table 9.7	Characteristics of the uMzimkhulu WTP	41
Table 9.8	Pump Station Details: uMzimkhulu River (weir), Raw Water	43
Table 9.9	Pipeline Details: uMzimkhulu System, Raw Water Supply Pipelines	43
Table 9.10	Pipeline Details: uMzimkhulu Potable Supply Pipelines	46
Table 9.11	Pump Details: uMzimkhulu Potable Water Pump Station	46
Table 9.12	Reservoir Details: uMzimkhulu System.....	46
Table 9.13	Characteristics of the Ibisi WTP.....	48
Table 9.14	Pump Station Details: Ibisi River (weir), Raw Water	50
Table 9.15	Pipeline Details: Ibisi System, Raw Water Supply Pipeline	50
Table 9.16	Pipeline Details: Ibisi Potable Supply Pipelines	53
Table 9.17	Pump Details: Ibisi Potable Water Pump Station	53
Table 9.18	Reservoir Details: Ibisi System.....	53
Table 10.1	Upper Mzimvubu and Upper Mzintlava hydrological characteristics (WR2012: Mzimvubu to Keiskamma Quat Info WMA 12Jul2015 Spreadsheet).....	66
Table 10.2	Crystal Springs Dam (DWS 2018: Hydrographic Surveys Dams Database, DWS 2019: List of Registered Dams Database, WR2012, DWS 2023: Drought Operating Rules for the Kokstad Water Supply System).....	74
Table 10.3	Yields of dams in the Mzintlava (Million m ³ /annum) (DWS 2023).....	76
Table 10.4	Kemptondale Dam (DWS 2018: Hydrographic Surveys Dams Database, DWS 2019: List of Registered Dams Database, WR2012, DWS 2023: Drought Operating Rules for the Kokstad Water Supply System).	77
Table 10.5	Characteristics of the Kokstad WTP	80
Table 10.6	Pump Station Details: Mzintlava River (weir), Raw Water.....	81
Table 10.7	Pipeline Details: Kokstad System, Raw Water Supply Pipelines.....	81
Table 10.8	Pipeline Details: Kokstad Potable Supply Pipelines.....	82
Table 10.9	Pump Details: Kokstad Potable Water Pump Stations	83
Table 10.10	Reservoir Details: Kokstad System	83

LIST OF ACRONYMS

AADD	Annual Average Daily Demand
AC	Asbestos Cement
ADWF	Average Dry Weather Flow
API	Antecedent Precipitation Index
AVGF	Autonomous Valveless Gravity Filter
BID	Background Information Document
BPT	Break Pressure Tank
BWL	Bottom Water Level
BWSP	Bulk Water Services Provider
BWSS	Bulk Water Supply Scheme
CAPEX	Capital Expenditure
CMA	Catchment Management Agency
CoGTA	Department of Co-operative Governance and Traditional Affairs
CWSS	Community Water Supply and Sanitation project
DAEA	Department of Agriculture and Environmental Affairs
DEA	Department of Environmental Affairs
DEFF	Department of Environment, Forestry and Fisheries
DM	District Municipality
DRDLR	Department of Rural Development and Land Reform
DWA	Department of Water Affairs
DWS	Department of Water and Sanitation
DWAF	Department of Water Affairs and Forestry
EFR	Estuarine Flow Requirements
EIA	Environmental Impact Assessment
EKZN Wildlife	Ezemvelo KZN Wildlife
EMP	Environmental Management Plan
EWR	Ecological Water Requirements
EWS	eThekweni Water Services
EXCO	Executive Committee
FC	Fibre Cement
FL	Floor level
FSL	Full Supply level
GCM	General Circulation Model
GDP	Gross Domestic Product
GDPR	Gross Domestic Product of Region
GVA	Gross Value Added
HDI	Human Development Index
IDP	Integrated Development Plan
IFR	In-stream Flow Requirements
IMP	Infrastructure Master Plan

IRP	Integrated Resource Plan
ISP	Internal Strategic Perspective
IWRM	Integrated Water Resources Management
KZN	KwaZulu-Natal
LM	Local Municipality
LUMS	Land Use Management System
MA	Moving Average
MAP	Mean Annual Precipitation
MAR	Mean Annual Runoff
MBR	Membrane Bioreactor
MMTS	Mooi-uMngeni Transfer Scheme
MMTS-1	Mooi-uMngeni Transfer Scheme Phase 1
MMTS-2	Mooi-uMngeni Transfer Scheme Phase 2
mPVC	Modified Polyvinyl Chloride
MTEF	Medium-Term Expenditure Framework
MTSF	Medium-Term Strategic Framework
MWP	Mkomazi Water Project
MWP-1	Mkomazi Water Project Phase 1
NCP-1	North Coast Pipeline I
NCP-2	North Coast Pipeline II
NCSS	North Coast Supply System
NGS	Natal Group Sandstone
NPV	Net Present Value
NRW	Non-Revenue Water
NSDP	National Spatial Development Perspective
NWSP	National Water Sector Plan
OPEX	Operating Expenditure
p.a.	Per annum
PES	Present Ecological Status
PEST	Political, Economical, Sociological and Technological
PGDS	Provincial Growth and Development Strategy
PPDC	Provincial Planning and Development Commission (KZN's)
PSEDS	Provincial Spatial Economic Development Strategy
PWSP	Provincial Water Sector Plan
RDP	Reconstruction and Development Programme
REC	Recommended Ecological Category
RO	Reverse Osmosis
ROD	Record of Decision
RQO	Resource Quality Objective
SCA	South Coast Augmentation
SCP	South Coast Pipeline
SCP-1	South Coast Pipeline Phase 1

SCP-2a	South Coast Pipeline Phase 2a
SCP-2b	South Coast Pipeline Phase 2b
SDF	Spatial Development Framework
SHR	St Helen’s Rock (near Port Shepstone)
STEEPLE	Social/demographic, Technological, Economic, Environmental (Natural), Political, Legal and Ethical
SWRO	Seawater Reverse Osmosis
TEC	Target Ecological Category
TWL	Top Water Level
uPVC	Unplasticised Polyvinyl Chloride
UUW	uMngeni-uThukela Water
WA	Western Aqueduct
WC	Water Conservation
WDM	Water Demand Management
WMA	Water Management Area
WRC	Water Research Commission
WSA	Water Services Authority
WSDP	Water Services Development Plan
WSNIS	Water Services National Information System
WSP	Water Services Provider
WTP	Water Treatment Plant
WWW	Wastewater Works

Spellings of toponyms have been obtained from the Department of Arts and Culture (DAC). DAC provides the official spelling of place names and the spellings, together with the relevant gazette numbers, can be accessed at <http://www.dac.gov.za/content/toponymic-guidelines-map-and-other-editors>.

When using any part of this report as a reference, please cite as follows:

uMngeni-uThukela Water, 2024. uMngeni-uThukela Water Infrastructure Master Plan 2024/2025 – 2054/55, Vol 1 - 10. Prepared by Planning Services, June 2024.

LIST OF UNITS

Length/Distance:	mm	millimetre
	m	metre
	km	kilometre
Area:	m ²	square metres
	ha	hectare
	km ²	square kilometres
Level/Altitude:	mASL	metres above sea-level
Time:	s	second
	min	minute
	hr	hour
Volume:	m ³	cubic metres
	Mℓ	megalitre
	million m ³	million cubic metres
	mcm	million cubic metres
Water Use/Consumption/Treatment/Yield:	ℓ/c/day	litre per capita per day
	kℓ/day	kilolitre per day
	Mℓ/day	megalitre per day
	million m ³ /annum	million cubic metres per annum
	kg/hr	kilograms per hour
Flow velocity/speed:	m/s	metres per second
Flow:	m ³ /s	cubic metres per second
	ℓ/hr	litres per hour
	m ³ /hr	cubic metres per hour

8. UMKHOMAZI SYSTEM

8.1 Synopsis of uMkhomazi System

The uMkhomazi Water Resource Region is relatively undeveloped (**Section 7.2.1 (b)** in Volume 2). One of the largest systems in the uMkhomazi Water Resource Region is the uMngeni-uThukela Water, owned and operated, Ixopo System. Water is abstracted from the Home Farm Dam, located on the iXobho River, a tributary of the uMkhomazi River, and a borehole, located on the local Ixopo Golf Course and supplied to the Ixopo WTP for treatment (**Figure 8.1, Figure 8.2 and Figure 8.3**).

The extent of iXobho catchment is entirely rural with urban elements linked to Ixopo town, which is located on the south bank of the river. Lower reaches of the river (50%) largely comprised of river-bank linked informal agriculture with settlements which are not in proximity to the river course.

Another system that was fairly small to date but has had planning and detailed design completed in previous years, is the Greater Donnybrook/ Bulwer Scheme. This project had been completed in stages with the bulk of the project meant to commence in the very near future. Water will be extracted from the new (future) Stephen Dlamini Dam on the Luhane River and treated on site in a new water treatment plant, thereafter distribution will be via the already constructed reticulation network (**Figure 8.12**). uMngeni-uThukela Water has been appointed as Implementing Agents for the project and a review of the detailed design will commence shortly. The construction of the dam will follow the review. The construction of the WTP and distribution system will be done by others.

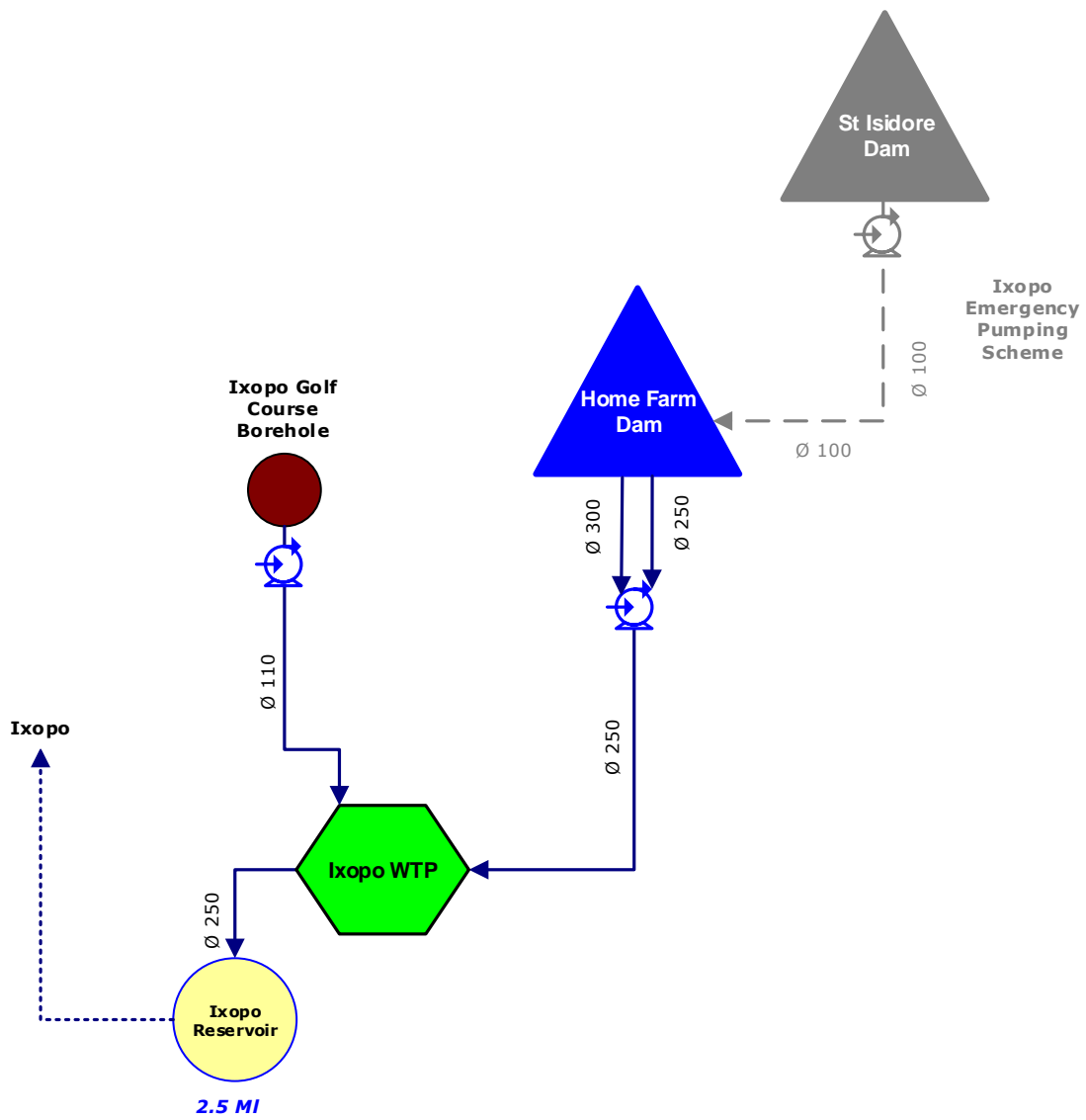

Figure 8.1 Schematic of the Ixopo System.

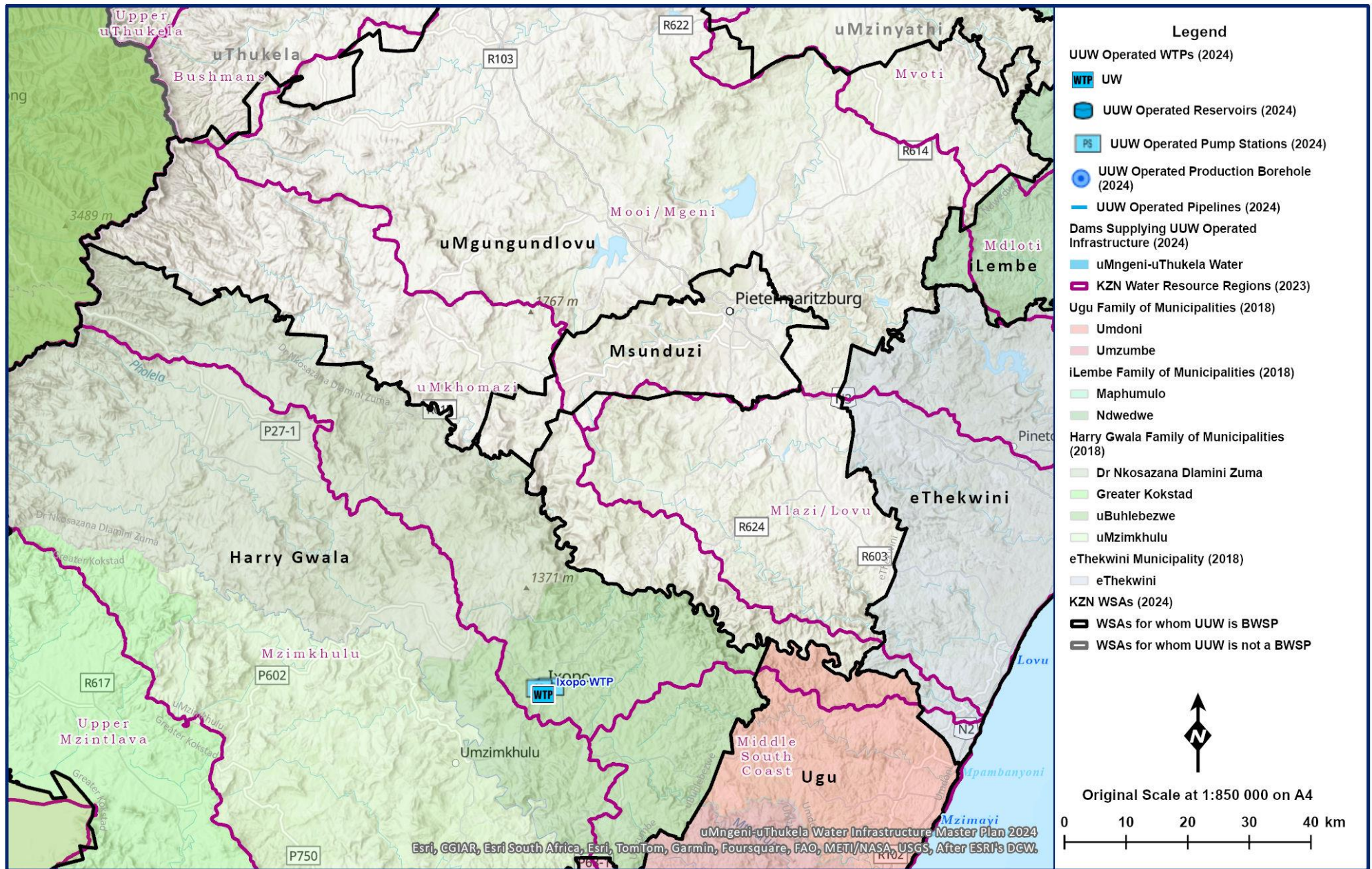

Figure 8.2 Location of the Ixopo System in the uMkhomazi Water Resource Region.

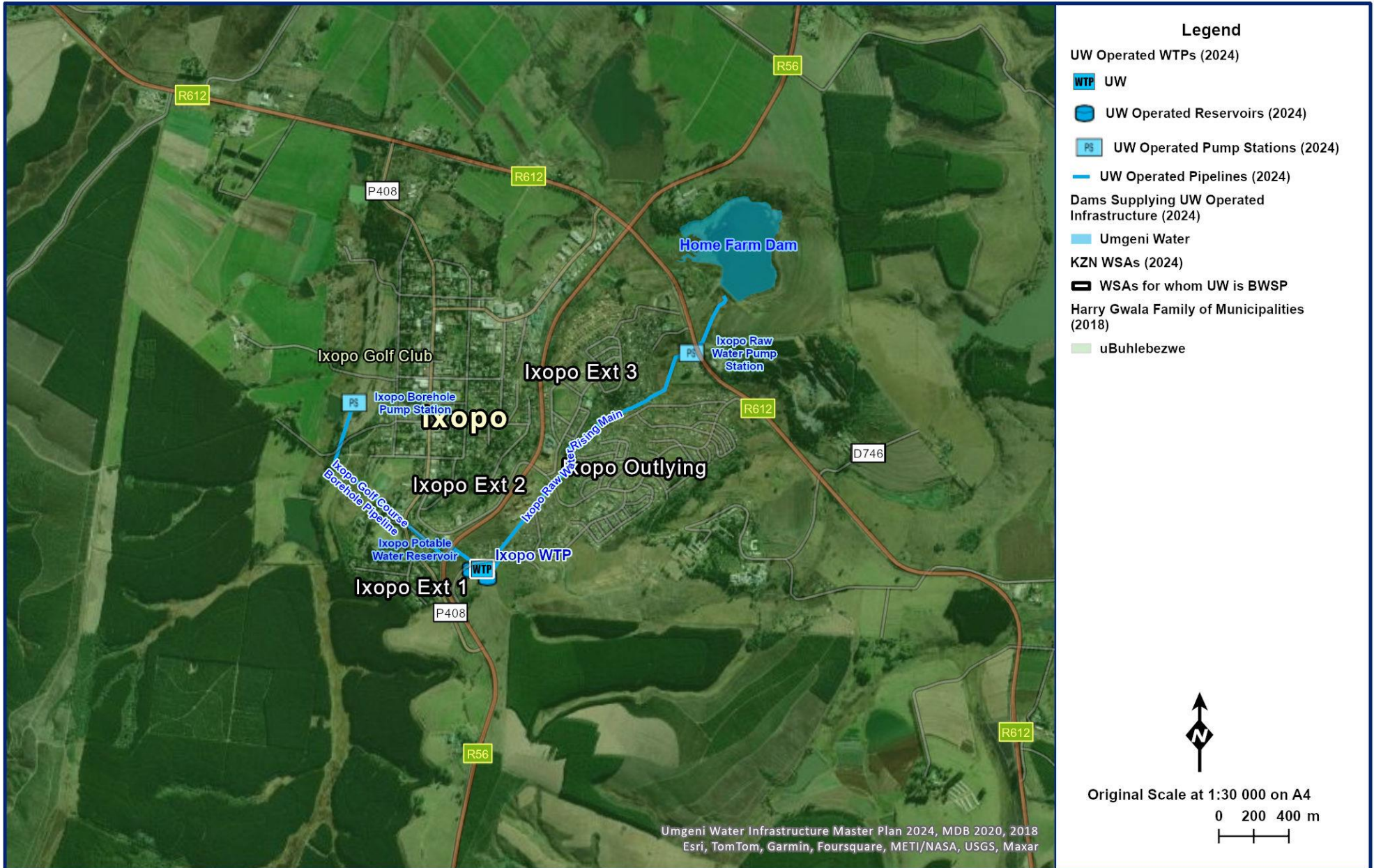

Figure 8.3 General layout of the Ixopo System.

8.2 Water Resources of the uMkhomazi System

8.2.1 Description of the uMkhomazi System Water Resource Region

Please refer to **Section 7.2.1 (b) in Volume 2** for the description of the uMkhomazi Water Resource Region. The Home Farm Dam is located within the U10K quaternary catchment on the iXobho River, a tributary of Nhlamvini River, which feeds the uMkhomazi River. The dam catchment is situated at the headwaters and has limited water resources due to catchment size.

8.2.2 Reserve of the uMkhomazi River

Please refer to **Section 7.2.2 (b) in Volume 2** for the description of the uMkhomazi Reserve.

In 2016, DWS undertook a study to determine present and target ecological classes. The Present Ecological State (PES) represents how the ecological condition of a river has been modified from its natural conditions. The measure is based on water quality variables, biotic indicators and habitat information that has been collected. Results are classified on a 6-point scale, from Category A (Largely Natural) to Category F (Critically Modified). Target ecological category (TEC) represents improvements that must be done on the ecological condition of the river based on flow or non-flow related issues.

The PES of various rivers in the U10K catchment of the uMkhomazi Region, where the iXobho catchment is located, is an ecological category C (DWS, 2016). The PES of iXobho River is category D as defined in the national river eco-classification table for desktop reserve determination (DWS, 2018). The category D PES is characterised by a significantly modified state owing to large instream and off channel farm dams, forestry and irrigation in the catchment. The TEC of iXobho River in the U10K catchment is category C/D (DWS 2016).

8.2.3 Existing Infrastructure and Yields

(a) Home Farm Dam

The Home Farm Dam catchment is situated within the U10K quaternary catchment and has a natural Mean Annual Runoff (MAR) of 40 million m³/annum and an area of 364 km². However, only 30.93% of the natural MAR flows into Home Farm Dam (UW, 2021). The dam has a limited incremental catchment area, viz. 77 km², with the majority of the runoff being intercepted by the upstream farm dams that have a combined capacity of 2.44 million m³ (UW, 2023). Home Farm Dam relies on spills and releases from the upstream Coppins and Lansdowne dams.

The water resources that support the Ixopo System comprises the Home Farm Dam (**Figure 8.3, Figure 8.4, Table 8.1 and Table 8.2**) and a production borehole. These two sources are used cooperatively to supply the current Ixopo town demand of 2.50 Mℓ/day. The yield of the Ixopo system can be augmented by the St. Isidore Dam located downstream of the Home Farm Dam (**Section 8.2.3 (a)**).



Figure 8.4 Home Farm Dam.

Home Farm Dam has a full supply capacity of 0.56 million m³ and a firm yield of 2.6 Mℓ/day without Ecological Water Requirement (EWR) releases being made from the dam. The production borehole operated by uMngeni-uThukela Water has a conservative yield of 400 kℓ/day irrespective of whether a 12, 14 or 24 hour pumping cycle is used. A silt survey of Home Farm Dam should only be undertaken every 10 years as the sedimentation impact is regarded as minimal with most sediment being trapped in the two upstream farm dams. An updated survey is now due as the previous one was undertaken in 2006.

Table 8.1 Characteristics of Home Farm Dam.

Catchment Details	
Incremental Catchment Area:	76.74 km ² ^a
Total Catchment Area:	76.74 km ² ^a
Mean Annual Precipitation:	841.79 mm ^a
Mean Annual Runoff:	5.25 million m ³ ^a
Annual Evaporation:	1 161.26 mm ^a
Dam Characteristics	
Gauge Plate Zero:	935.80 mASL
Full Supply Level:	939.80 mASL
Spillway Height:	4 m
Net Full Supply Capacity:	0.56 million m ³
Dead Storage:	0.0 million m ³
Total Capacity:	0.56 million m ³
Surface Area of Dam at Full Supply Level:	0.20 km ²
Original Measured Dam Capacity	0.56 million m ³ (January 2000)
Second Measured Dam Capacity	0.56 million m ³ (January 2006)
Dam Type:	Earth embankment
Crest Length:	Spillway Section: 20m (approx.) Non-Spillway Section: 140m
Type of Spillway:	Uncontrolled
Capacity of Spillway:	Not Available
Date of Completion:	1977
Date of Area Capacity Survey:	2006
Date of next Area Capacity Survey:	2023

^a Umgeni Water (2021)

Table 8.2 Existing Dams in the Ixopo Region.

Impoundment	River	Capacity (million m³)	Purpose
Home Farm Dam	iXobho	0.56	Domestic

Home Farm can be augmented via an emergency raw water transfer scheme from the St. Isidore Dam when needed.

Refer to the Upper Mzintlamva Infrastructure Masterplan chapter for Crystal Springs Dam.

8.2.4 Operating Rules

There are two raw water resources supplying the Ixopo WTP. During times, when the Home Farm Dam (surface water supply) is spilling, the borehole abstraction rate (ground water supply) should be reduced to a minimum requirement that would be demand dependent.

The Home Farm Dam and the golf course borehole supplies the demand without the support of the upstream Coppins and Lansdown farm dams until the Home Farm Dam storage level drops to 40% (this is a conservative trigger level as per recent hydrological seasons). If the dam level drops below 40%, water is then released from these upstream dams to the Home Farm Dam. These farm dams would continue to support the Home Farm Dam until dead storage is reached. Restrictions are imposed in the system when the level of Home Farm Dam decreases to below 40% of full supply capacity.

The Home Farm Dam storage has consistently remained at high levels from 2020/21 to 2023/24 hydrological years due to the good rainfall received in the Ixopo catchment. As a result, no water supply curtailments were imposed in the system over the 2023/24 period. Raw water abstracted from the Home Farm Dam to supply Ixopo WTP was barely supplemented by the borehole. Pumping from the borehole only took place for a short period in 2023 as a result of pump vandalism. The pump has recently been refurbished.

8.3 Supply Systems

8.3.1 Description of the Ixopo System

As discussed in [Section 8.2.3](#), the Home Farm Dam is the primary source of raw water supply to Ixopo. As shown in **Figure 8.3**, raw water is gravity-fed from the dam (FSL = 939.84 mASL) a distance of 418.4 m to the raw water pump station (located at the entrance to the Ixopo Wastewater Works) and then pumped a distance of 1.382 km to the WTP (Raw Water Reservoir TWL = 1110.62 mASL; **Figure 8.5**).



Figure 8.5 Ixopo Water Treatment Plant.

The Ixopo Golf Course borehole is a single production borehole situated on the local golf course (**Figure 8.3**). This borehole is used conjunctively with the Ixopo Dam to meet the water requirements at the WTP but has been out of commission as a result of vandalism from February 2021 to date. Discussions are being held with the DM to determine the ownership of the land to seek permission to fence the borehole. The raw water from the borehole feeds directly into the chlorination contact chamber. At times, as much as 15 to 20% of the total supply at the WTP is obtained from the borehole. Water is pumped from this production borehole (approximately 997 m ASL) via a 1.38 km rising main to the WTP. Details of the raw water pipeline from the dam and the pipeline from the borehole are shown in **Table 8.3**. Details of the pump station and reservoir are shown in **Table 8.4** and **Table 8.5** respectively.

The capacity of the WTP has been upgraded a number of times. The initial capacity on commissioning was 364 kℓ/day. It was then upgraded to 2 Mℓ/day in 1999. The commissioning of the Ixopo Clarifier in September 2007 increased the capacity to 2.35 Mℓ/day. Water purification at the plant was predominantly via a sand filtration process but with the recent upgrade to the filters to include pressure filters, the increased capacity of the Ixopo WTP is 3.1 Mℓ/day. In 2015 the slow sand filters (7) were decommissioned and three pressure filters are now being used as alternatives. A 2 Mℓ/day package plant was installed and was commissioned in March 2016. This increased the capacity of the plant to 4.1 Mℓ/day. The raw water gravity pipeline from the dam to the pump sump has been augmented with a 300 mm diameter uPVC pipeline and was commissioned in December 2012. The augmentation has increased the raw water pipeline capacity to 5.45 Mℓ/day (combined pipe diameters). Although the plant has the capacity to produce 4.4 Mℓ/day the dam has a yield of 2.6 Mℓ/day. Details of the WTP are shown in **Table 8.6**.

Potable water is sold “at the fence” of the WTP to the Harry Gwala District Municipality, which is responsible for reticulation within the town of Ixopo and the adjacent peri-urban areas within uBuhlebezwe Local Municipality, however on occasion tankers are deployed to Ixopo WTP for supply outside of uBuhlebezwe. This has subsequently been halted and only done via special permission from uMngeni-uThukela Water. The Ixopo Potable Water Reservoir (**Figure 8.3**) is located at the WTP and acts as a balancing and service reservoir.

Table 8.3 Pipeline details: Ixopo System.

System	Pipeline Name	From	To	Length (km)	Nominal Diameter (mm)	Internal Diameter (mm)	Material	Capacity* (Mℓ/day)	Age (years)
Ixopo	Ixopo Raw Water Gravity Pipeline	Ixopo Dam	Ixopo Raw Water Pump Station	0.42	250	Unknown	FBE Coated, Cement Mortar Line, Bell and Spigot, Welded Steel	1.79	25
Ixopo	Ixopo Raw Water Gravity Pipeline	Ixopo Dam	Ixopo Raw Water Pump Station	0.42	300	Unknown	uPVC	2.83	10
Ixopo	Ixopo Raw Water Rising Main	Ixopo Raw Water Pump Station	Ixopo WTP	1.38	250	Unknown	FBE Coated, Cement Mortar Line, Bell and Spigot, Welded Steel	6.37	25
Ixopo	Ixopo Golf Course Borehole Pipeline	Ixopo Golf Course Borehole	Ixopo WTP	1.50	110	Unknown	uPVC	1.23	>20

* Capacity based on a velocity of 2.0 m/s for gravity mains and 1.5 m/s for rising mains.

Table 8.4 Pump details: Ixopo System.

System	Pump Station Name	Number of Duty Pumps	Number of Standby Pumps	Pump Description	Supply From	Supply To	Static Head (m)	Duty Head (m)	Duty Capacity (Mℓ/day)
Ixopo	Ixopo Raw Water	1	1		Ixopo Dam	Ixopo WTP	170.36	172.123	2.7
Ixopo	Borehole	1		22kw	Golf Course BH	Ixopo WTP	82 (approx.)	90.7	0.4

Table 8.5 Reservoir details: Ixopo System.

System	Reservoir Site	Reservoir Name	Capacity Mℓ	Function	TWL (m ASL)	FL (m ASL)
Ixopo	Ixopo WTP	Ixopo Potable Water Reservoir	2.5	Distribution	1105.23	1101.23
Ixopo	Ixopo WTP	Ixopo Raw Water Reservoir	0.272	Header Tank for Treatment	1110.62	1108.62

Table 8.6 Characteristics of the Ixopo WTP.

WTP Name:	Ixopo WTP
System:	Ixopo System
Maximum Design Capacity:	4.4 Mℓ/day (2 Mℓ/day Main Plant + 2 Mℓ/day Package Plant + 0.4 Mℓ/day Bore-hole)
Current Utilisation:	2.59 Mℓ/day
Raw Water Storage Capacity:	272 m ³
Raw Water Pipeline Supply Capacity:	5.45 Mℓ/day– from dam
Total Raw water Supply Capacity	3.0 Mℓ/day (2.6 Mℓ/day dam yield + 0.4 Mℓ/day bore-hole yield)
Pre-Oxidation Type:	Pre-chlorination and Potassium permanganate
Primary Water Pre-Treatment Chemical:	Aluminium Sulphate
Total Coagulant Dosing Capacity:	30.0 ℓ/h (4 x 7.5 L/h dosing pumps – 2 duty and 2 standby pumps)
Rapid Mixing Method:	Mechanical mixer followed by flow over weir
Clarifier Type:	Dortmund (main plant) and Lamella (package plant)
Number of Clarifiers:	5 (3 Dortmund; 2 Lamella)
Total Area of all Clarifiers:	168 m ² (126 m ² Dortmund; 42 m ² Lamella)
Total Capacity of Clarifiers:	5 Mℓ/day (3 Mℓ/day on main plant and 2 Mℓ/day on package plant)
Filter Type:	Pressure Filters
Number of Filters:	6
Filter Floor Type	False floor (10mm Steel plate) with nozzles
Total Filtration Area of all Filters	33.36 m ²
Total Filtration Design Capacity of all Filters:	4 Mℓ/day
Total Capacity of Backwash Water Tanks:	40 m ³ (2 x 20m ³ Jojo tanks)
Total Capacity of Sludge Treatment Plant:	There is no sludge treatment onsite
Capacity of Used Washwater System:	60 m ³ (3 x 20 m ³ Jojo tanks)
Primary Post Disinfection Type:	Chlorine Gas
Disinfection Dosing Capacity:	4 kg/h – Pre-chlorination 2 kg/h – Post disinfection
Disinfectant Storage Capacity:	Stored in 70 kg Cylinders
Total Treated Water Storage Capacity:	2.5 Mℓ (on-site reservoir)

8.3.2 Status Quo and Limitations of the Ixopo System

Water demand at Ixopo is influenced by three factors: increased sales to new consumers, movement in sales to existing consumers and the movement in unaccounted for water. The net impact of these three factors on the Ixopo demand node is shown in **Figure 8.6**.

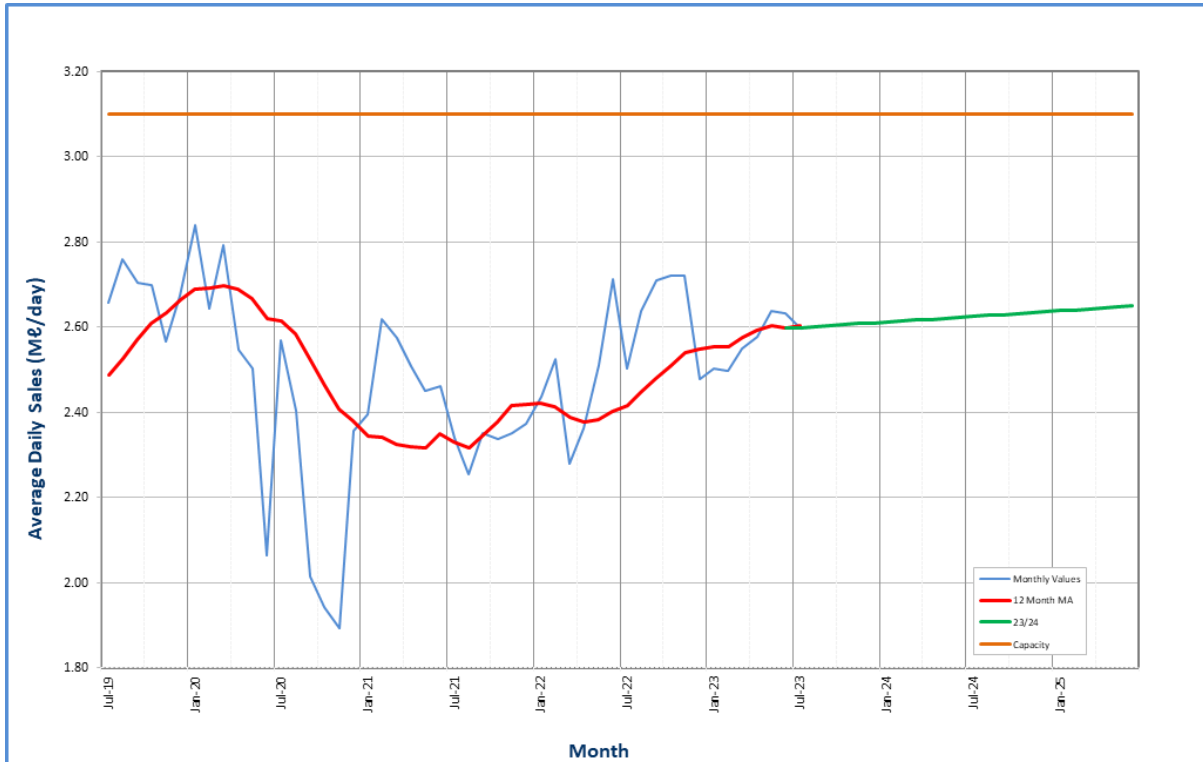

Figure 8.6 Water Demand from Ixopo WTP.

Average daily sales from the WTP, as at June 2023, amounted to 2.597 Mℓ/day. This is a year-on-year growth of 8.08 % from 2022. The demand increase over the year can be attributed a steady increase in the usage within the town. The exact area of increase cannot be determined by U UW as the supply to the town is managed by the DM and no secondary bulk or reticulation sales records are available. The catchment has been receiving above average rainfall for the last two years and this has resulted in the dam being at full capacity for the majority of the year with a drop to 88% from September 2022 to November 2022 and a recovery to full capacity in the middle of November 2022.

In September 2023, a projected growth of 1.0% had been predicted for Harry Gwala District Municipality. Construction of a new development, the Thubalethu Community Residential Units (CRU), has commenced. The HGDM is still to inform U UW of the date at which the project would be completed. The CRU Phase 1 is to house 150 units with an approximate water usage of 0.12 Mℓ/day.

An analysis of the daily historical sales (November 2022 to October 2023) of water for the Ixopo WTP is illustrated in **Figure 8.7**. It shows that for 0 % of the time, the WTP was operated above its design capacity of 4.4 Mℓ/day and that for 0 % of the time the WTP was being operated above the optimal operating capacity (80% of design capacity).

The production borehole at the golf course was vandalised and was no longer operational at the time of writing this report. The Operations Division is in the process of repairing the borehole and will equip it with a new pump once the area is fenced.

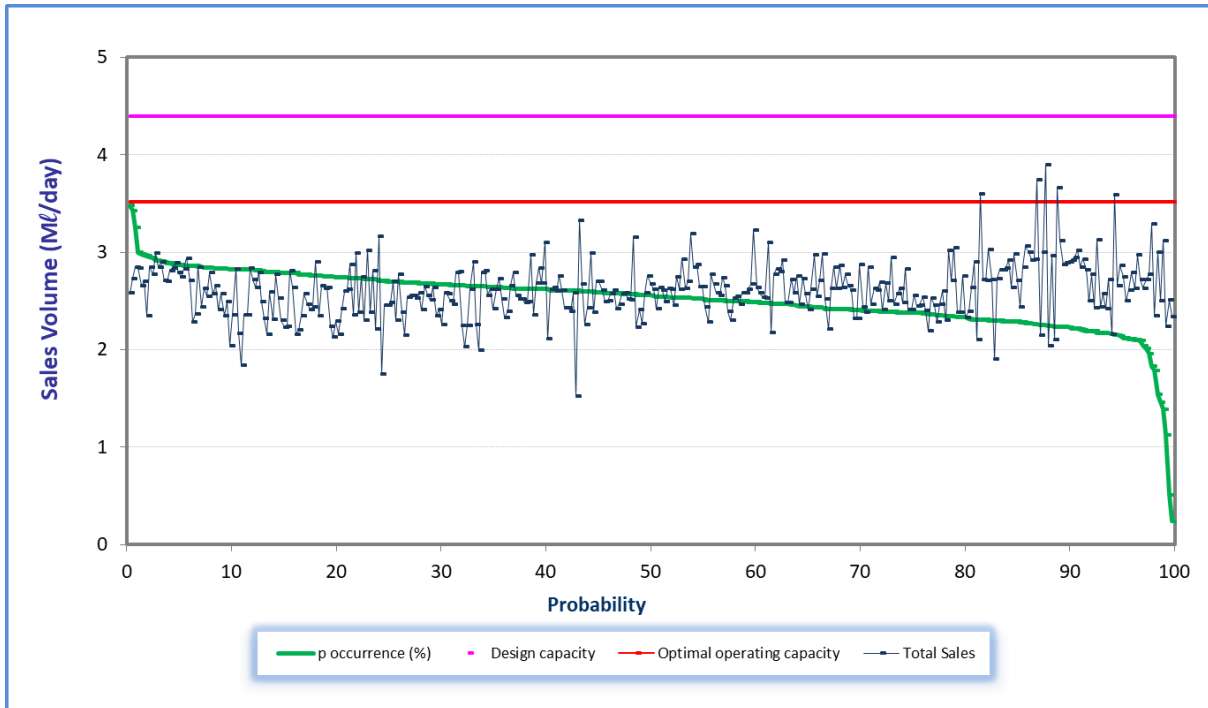

Figure 8.7 Analysis of historical production at Ixopo WTP (November 2022 to October 2023).

The dam and borehole have sustainable yields of 2.6 Mℓ/day and 0.4 Mℓ/day under normal operating conditions. During normal operations there is, therefore, sufficient resource to meet the short-term requirements. The yield of the borehole is adequate as a medium-term resource for the system.

The water supply between the dam and the WTP is problematic. An assessment of the supply infrastructure revealed that:

- Under certain conditions, hydraulic problems exist between the dam operating level and the level in the sump at the raw water pump station.
- There are capacity constraints with the pump delivery pipeline to the WTP with the pipe size reducing for a portion of the route.
- An analysis of the raw water system should be undertaken to overcome these raw water supply constraints.

The protection of the borehole equipment is essential as the borehole augmentation ensures adequate supply to the system and increases the storage capacity for the dry winter months.

Non-Revenue Water (NRW) still remains a significant contributor to the water demands in Ixopo. The average NRW for the year ending June 2022 (for Ubuhlebezwe LM) was 63.9% which is slightly lower than the previous year's average of 65.2%. The planned spatial distribution of new development/demand nodes in the area may lead to options, which consider new WTP sites and scheme configurations such as the uMzimkhulu Bulk Water Supply Scheme.

There are no significant water resources in close proximity to the WTP that can be utilised to augment the system. The long-term water resource requirements will thus have to be sourced from further afield. uMngeni-uThukela Water has been issued with a directive from the Department of Water and

Sanitation to implement the Stephen Dlamini Dam as part of the Greater Bulwer/Donnybrook Scheme in the Nkosazana Dlamini Zuma Local Municipality. This scheme will provide a sustainable potable water supply to the Greater Bulwer, Gala, Nkwazela and Donnybrook areas. The Harry Gwala District Municipality also plan to use this scheme to supply bulk water to the Greater Ixopo area via the Comrie Dam. Comrie Dam was raised by 2m in 2017 to increase the yield to meet projected demands. There is a possibility to raise the Comrie Dam by an additional 2m and that option will be investigated further to determine the financial viability of this project. The Stephen Dlamini Dam forms part of the project and uMngeni-uThukela Water will be assisting with the implementation of this dam; the project is at a stage where the implementing agent agreement has been signed and the design review will commence. In the interim, a weir on the Luhane River supplies water to the area via a 1.5 Mℓ/d package plant.

The Mkomazi Water Project will be implemented in the region in the future (Section 7.5.2 (a) in Volume 2). This project will primarily provide an inter-basin transfer to the uMngeni System. Although no plans are currently in place to provide water to the communities in Harry Gwala District Municipality from this project, an investigation was conducted and a detailed feasibility is required.

Regional schemes are currently being investigated by both Harry Gwala District Municipality and uMngeni-uThukela Water with the objective of providing the District with a sustainable water supply. Five regional schemes have been identified. uMngeni-uThukela Water has completed a pre-feasibility and detailed feasibility study for the regional schemes that will supply bulk water to the Mzimkhulu Local Municipality (Section 8.5.2). The Environmental Assessment Practitioner is currently working on the EIA.

8.4 Water Balance/Availability

The water resources availability and projected demands are summarised in **Figure 8.8**. The demand projection illustrated in **Figure 8.8** indicates that there has been a gradual increase in demand to the normal supply i.e. 2.6 Mℓ/day in the recent months. A nominal growth factor of 1.0% per annum was used to project the demands thereafter. This figure is conservative and, should the water demand management initiatives be further implemented, there would be a decrease in the demand. The Harry Gwala District Municipality has not indicated any definite proposed developments in the near future and should this change, the projections will be amended accordingly.

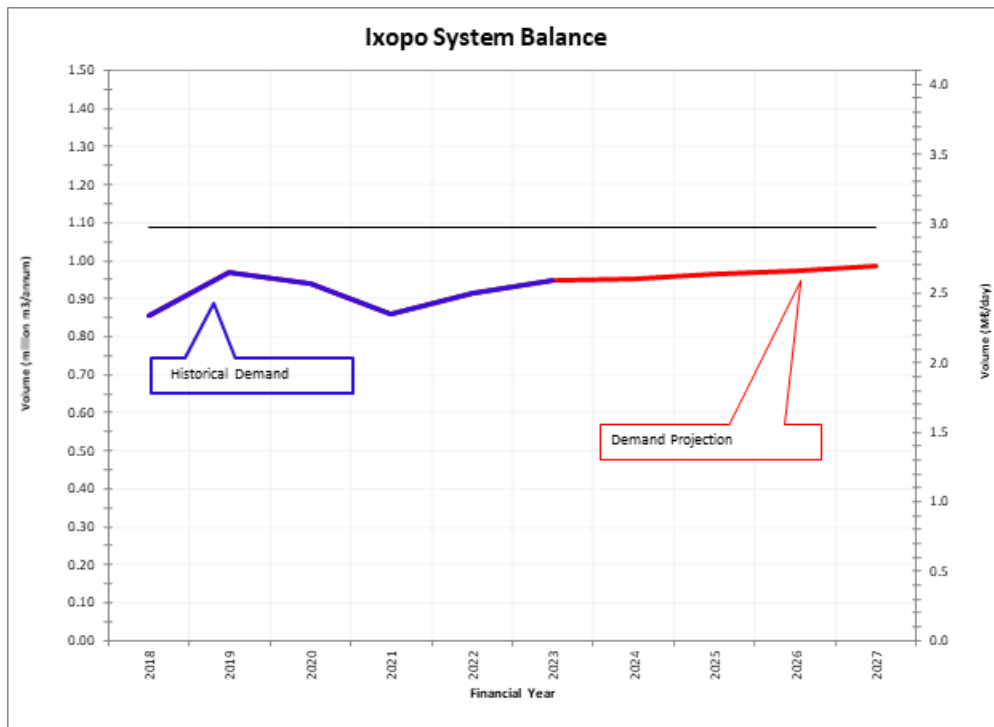

Figure 8.8 Ixopo System Water Balance.

8.5 Recommendations for the uMkhomazi System

8.5.1 System Components

Please refer to **Section 7.5.1 (b) in Volume 2** for the recommended water resource infrastructure in the uMkhomazi Water Resource Region.

The following measures are recommended to address the supply issues mentioned:

- The size of the installed raw water pumps from Home Farm Dam and the pipeline to the WTP should be reviewed.
- The configuration and levels of the sump and in-take to the raw water pumps from Home Farm Dam should be reviewed.
- The Home Farm Dam catchment EWR (scaled down from U10K desktop determined EWR) cannot be sustainably supplied from the dam. A comprehensive determination of the reserve needs to be conducted.
- Undertake a pre-feasibility and detailed feasibility study to determine options of future water resources to serve the town of Ixopo.
- Implement the uMzimkhulu Bulk Water Supply Scheme as a means of attaining universal access throughout the region (**Section 8.5.2 a**)
- Implement the Greater Bulwer Donnybrook Regional Bulk Water Supply Scheme as a means to attaining universal access throughout the region (**Section 8.5.2 b**)

8.5.2 Projects

(a) uMzimkhulu Bulk Water Supply Scheme

Planning No.	162.6
Project No.	UI0816A
Project Status	Detailed Feasibility (Completed 2018)

(i) Background

The Mzimkhulu Local Municipality is currently supplied by numerous small non-sustainable schemes. Water supply in this area is isolated with little or no regional planning in place and the schemes in place provide only modest relief for the most immediate need. The recommended approach of this project is of a regional nature which is sustainable and provides proper operational, maintenance and treatment systems in place. This holistic approach will allow the uMzimkhulu Bulk Water Supply Scheme to not only supply the Mzimkhulu Local Municipality but also supply parts of the Dr Nkosazana Dlamini-Zuma and uBulebezwe Local Municipalities and has the potential to supply the southern coastal areas within the KwaZulu-Natal province.

(ii) Project Description

The locality map and extent of the project are shown in **Figure 8.9**. The Mzimkhulu Local Municipality (KZN435) is predominantly rural in nature with dispersed settlement patterns.

The scheme will consist of an earth fill dam with an impermeable core, referred to as the New Biggen Dam. The dam would have a capacity of 77 million cubic metres of water and has a yield of 348 Mℓ/day. The scheme would consist of a WTP at the edge of the dam that would produce 43.3 Mℓ/day. The main pump station would be located adjacent to the WTP and pump water via two rising mains north and south of the WTP to two command reservoirs. Most of the scheme there onwards would be supplied under gravity with minimal pumping required. The scheme would require three smaller pump stations, approximately 450 km of pipeline varying from 150 mm to 800 mm and 32 reservoirs placed at strategic points to maximise supply. The details of this project are summarised in **Table 8.7**.

This scheme will have the capacity to supply the entire Mzimkhulu Local Municipality and parts of adjacent local municipalities with potable water and would have the option to be upgraded in the future.

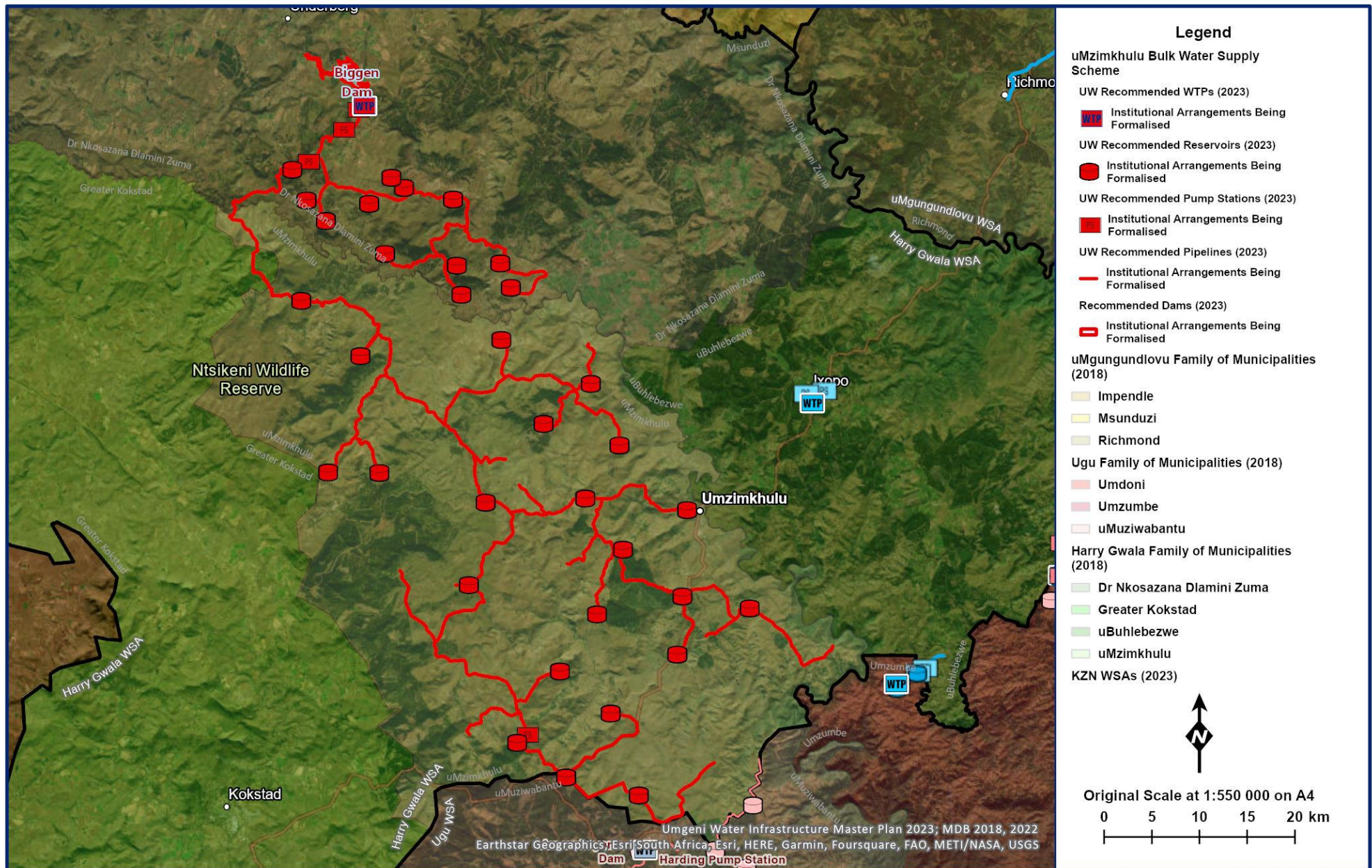

Figure 8.9 Proposed uMzimkhulu Bulk Water Supply Scheme.

Table 8.7 Project information: uMzimkhulu Bulk Water Supply Scheme.

<p>Project Components:</p>	<p>Phase 1: 43.3 Mℓ/day Water Treatment Plant, associated pump stations, command reservoir A, rising mains to reservoir A and gravity mains from a south westerly direction towards Mzimkhulu town. This phase will also supply water to Greater Kilimon and consist of 162 km of pipelines ranging from 150 mm to 800 mm in total.</p> <p>Phase 2: Comprises of the construction of reservoirs, pump stations and gravity mains branching of the main supply lines constructed in Phase 1. A total of 134 km of pipelines ranging in diameter from 150 mm to 650 mm will be constructed in this phase.</p> <p>Phase 3: This phase will consist of the construction of the sub-mains branching off the mains constructed in the two previous phases as well as the terminal reservoirs. A total length of 164 km of pipelines ranging in diameter from 150 mm to 500 mm will be constructed in this phase.</p>
<p>Capacity (WTP):</p>	<p>43.3 Mℓ/day, provision will be made to upgrade the WTP should the need arise.</p>

(iii) Institutional Arrangements

Discussions between Harry Gwala DM as the Water Services Authority, uMngeni-uThukela Water and the Department of Water and Sanitation needs to occur to address the institutional, management and financial implications with respect to the ownership and management of the proposed new infrastructure.

(iv) Beneficiaries

The scheme will primarily serve the Mzimkhulu Local Municipality area and possibly portions of other Local Municipalities within Harry Gwala District Municipality. An estimated 256 740 people may be served by this scheme.

(v) Implementation

The detailed feasibility has been completed and the document has been reviewed. The detailed feasibility provides implementing timeframes, project staging and funding options together with an Infrastructure Readiness Submission that can be presented to DWS. The total value of the project is estimated at R7.0 billion and the project could be completed in 5 years provided the 3 phases are completed concurrently. Investigations have commenced into the funding of the proposed scheme by MISA, DWS and CoGTa.

(b) The HGDM Regional Bulk Water Supply Scheme (HGDM RBWSS)

Planning No.	162.8
Project No.	New Project
Project Status	Construction of Phase 2 (Phase 1 complete)

(i) Project Description

Background

The Harry Gwala District Municipality (HGDM), formerly the Sisonke District Municipality (DM), is the Water Services Authority (WSA) that serves the towns of Bulwer, Ixopo, Creighton and Donnybrook as well as the surrounding rural areas in the southern part of the KwaZulu-Natal Province (KZN). The HGDM identified the need for a Regional Bulk Water Supply Scheme (RBWSS) as a sustainable long-term solution for improving water supply reliability in the HGDM Supply Area, where many communities currently do not have reliable potable water resources. The HGDM Regional Bulk Water Supply Scheme (HGDM RBWSS), which was formerly known as the Greater Bulwer Donnybrook RBWSS, will fulfil this purpose.

During 2007 uMngeni-uThukela Water completed the Greater Bulwer Bulk Water Supply Scheme, Bulk Distribution Infrastructure Reconnaissance Study. A recommendation was to undertake a detailed feasibility study for a dam on the Luhane River. The need for a dam was also identified in the HGDM Master Plan. uMngeni-uThukela Water undertook the Detailed Feasibility Study for the proposed Stephen Dlamini Dam, formerly known as Bulwer Dam and referred to as the Dam hereafter, in 2009. An Environmental Impact Assessment (EIA) was also undertaken in terms of the relevant applicable legislation at the time in 2009 as part of the Planning Investigations for the Dam.

The extensive network of bulk potable water pipelines of the HGDM RBWSS will link into a series of standalone schemes that have previously been reliant on small-localised water sources such as boreholes and springs, in order to supply the projected 2040 water requirement of 4.02 million m³/annum (11 Mℓ/d) from the HGDM RBWSS. Possible options to augment supply to the HGDM RBWSS were also investigated as part of the Department of Water and Sanitation's (DWS's) recent Planning Investigations for the uMkhomazi Water Project Phase 1 (uMWP-1), referred to as the uMWP-1.

uMngeni-uThukela Water has received a written directive, in terms of Section 74 of the National Water Act, 1998 (Act No. 36 of 1998) and Section 41 of the Water Services Act, 1997 (Act No. 108 of 1997) to fund and implement the Stephen Dlamini Dam project on behalf of the Department of Water and Sanitation. (DWS Letter: Minister of Human Settlements, Water and Sanitation. Dated 05/06/2020)

Project Components

The HGDM RBWSS comprises of the Stephen Dlamini Dam as the main raw water supply source, a 10 Mℓ/day Water Treatment Plant (WTP), a 20 Mℓ command reservoir, various storage reservoirs and a network of potable water supply pipelines. Prior to the construction of the RBWSS an emergency intervention has been implemented, see below for details.

Emergency Intervention (completed)

In 2011, it became apparent that the regional project would only address the medium to long-term needs for the town of Bulwer, as it was unlikely for the dam to be constructed in the short term. This left Bulwer with an immediate need and hence possible solutions were investigated to link the dam project and the Luhane River in order to develop a scheme that will provide water to Bulwer in the interim. The outcome of these investigations resulted in the implementation of the following:

- A weir on the Luhane River (**Figure 8.10** and **Figure 8.11**).
- An abstraction system and pump station at the weir site.
- A package treatment plant at the weir site of 1.5 Mℓ/day
- A pipeline from the package WTP on the Luhane River to Bulwer Town and to a point to provide water to the Donnybrook/Gala area as well.
- A reservoir positioned at the existing reservoir and Water Treatment Works in Bulwer Town.



Figure 8.10 Weir and Package Plant on the Luhane River

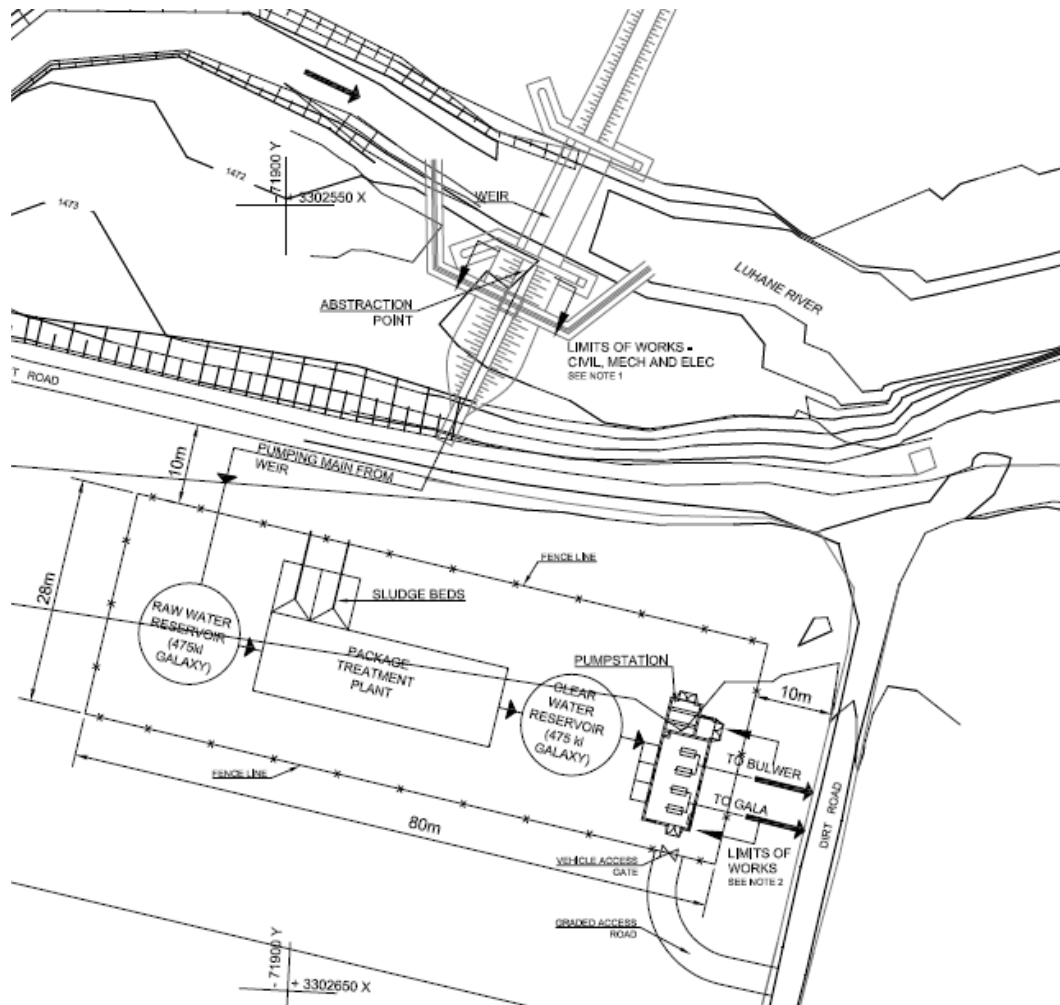

Figure 8.11 Layout of the Weir and Package Plant

The existing water treatment works is adjacent to the Luhane River, to the North of the proposed site of the new Stephen Dlamini Dam WTP. The existing package plant was completed around 2014 and has a capacity of 1.5 Mℓ/day.

Stephen Dlamini Project

Scope of Bulk Water Infrastructure to be implemented by uMngeni-uThukela Water as per the directive:

- A 600 m long and 29.50m high Zoned Earth fill Embankment Dam : Capacity – 9.78 million m³

The other components if the project will be funded and constructed by others.

The Stephen Dlamini Dam is a key project to ensuring the timely implementation of the uMkhomazi Water Supply project.

(ii) Beneficiaries

The HGDM RBWSS will provide 89 892 people (2020) with an assured supply of potable water (Figure 8.12).

(iii) Implementation

The construction of this project is envisaged to have a five year duration, and if started in 2026, it should be completed by June 2031. The project will require a detailed programme and further investigation will be conducted before implementation. The estimated cost for implementation of all components is R 1.2 billion, as per 2020 pricing.

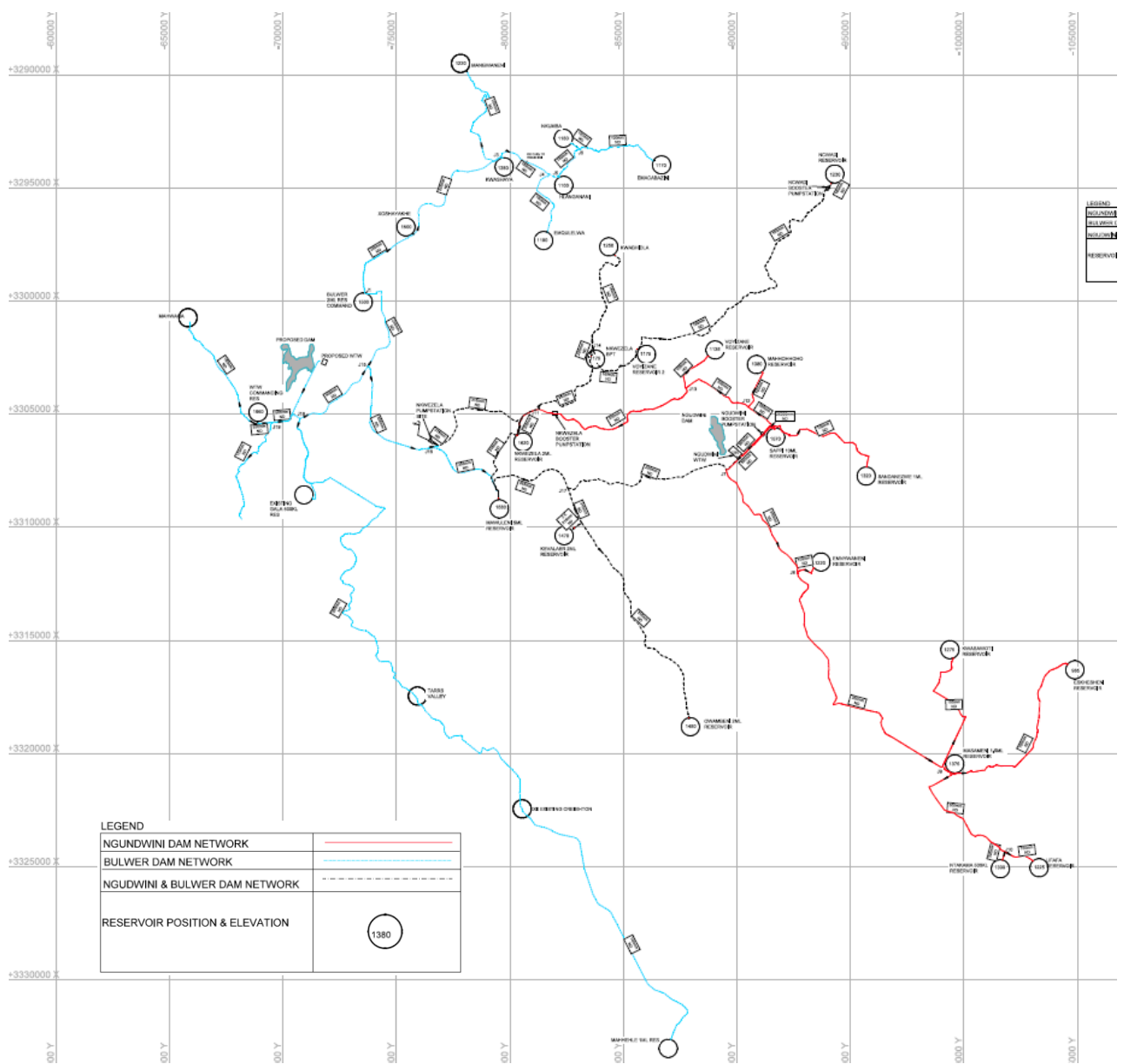

Figure 8.12 Overall Layout of the HGDM RBWSS

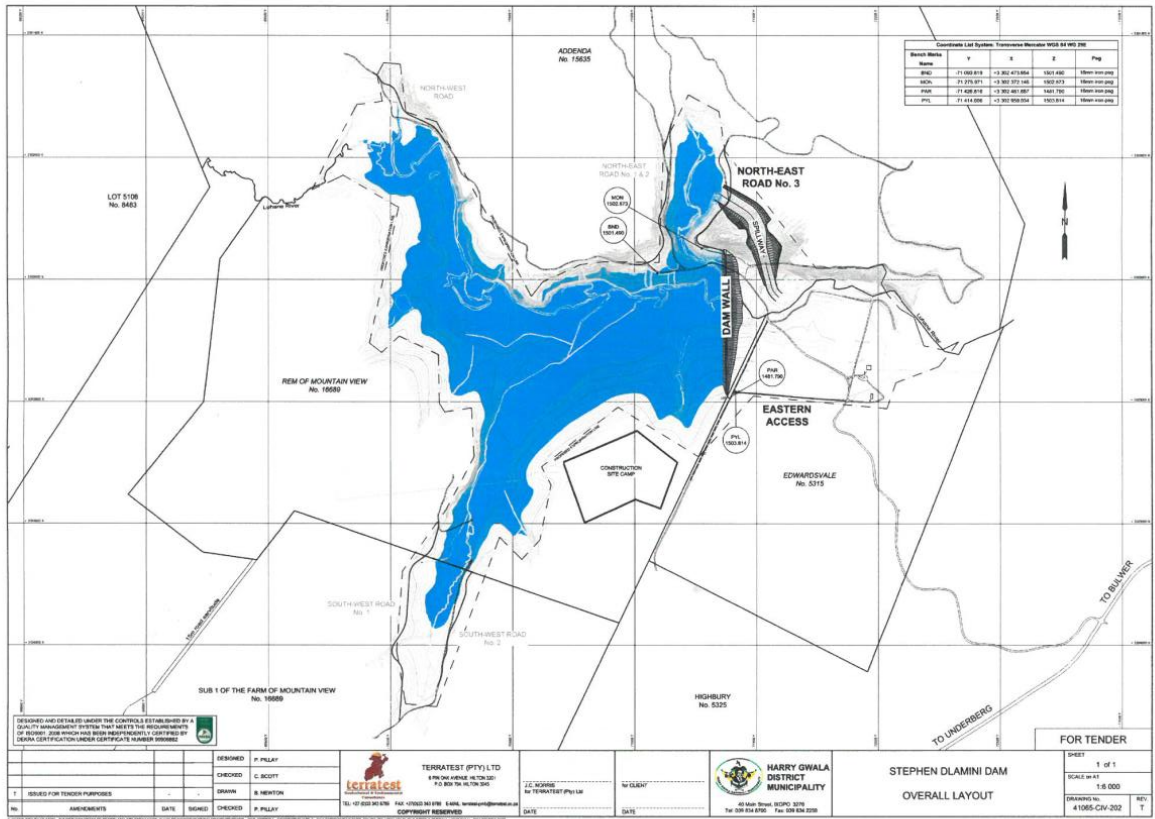

Figure 8.13 Layout of Stephen Dlamini Dam

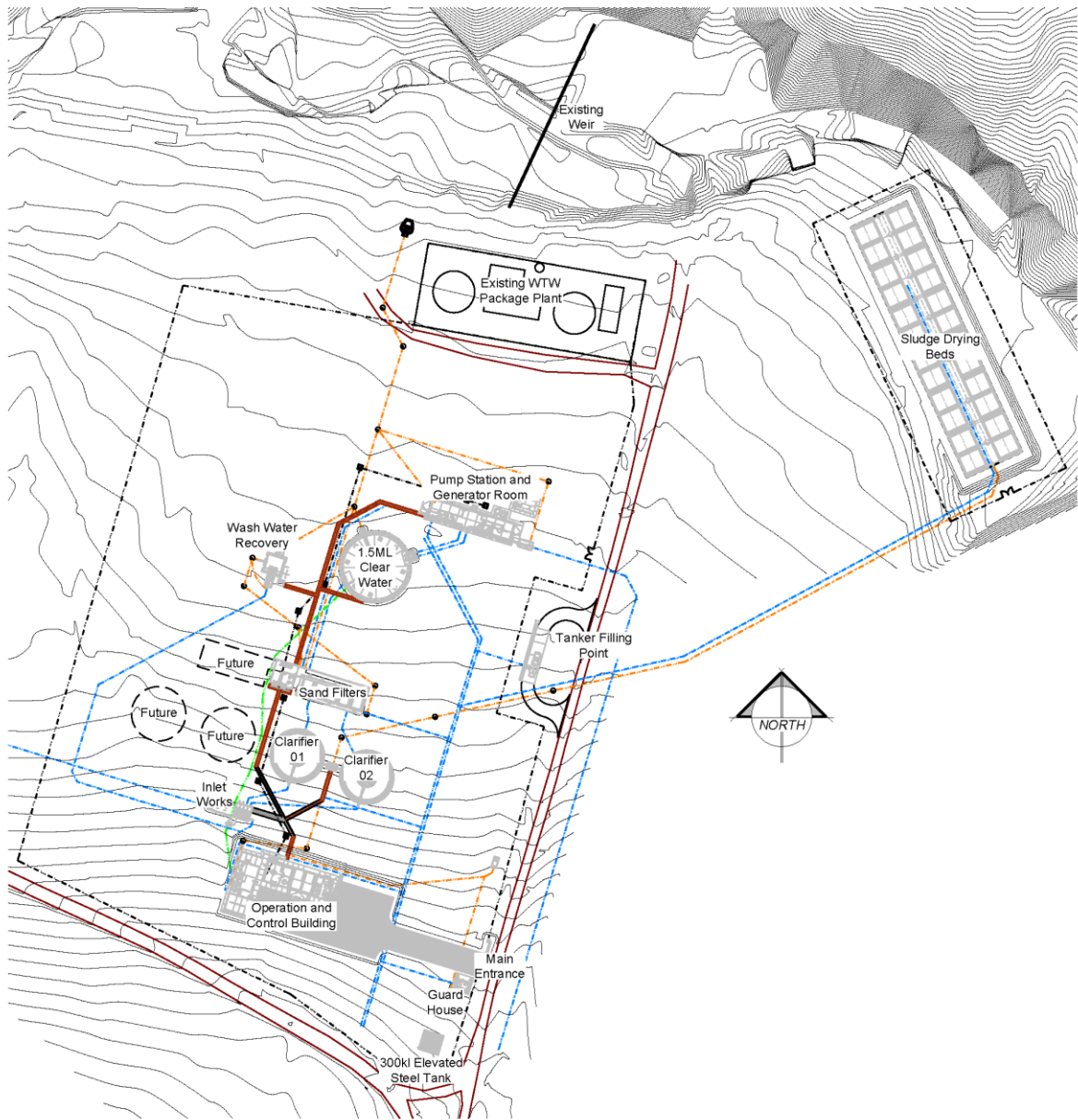

Figure 8.14 Stephen Dlamini WTP

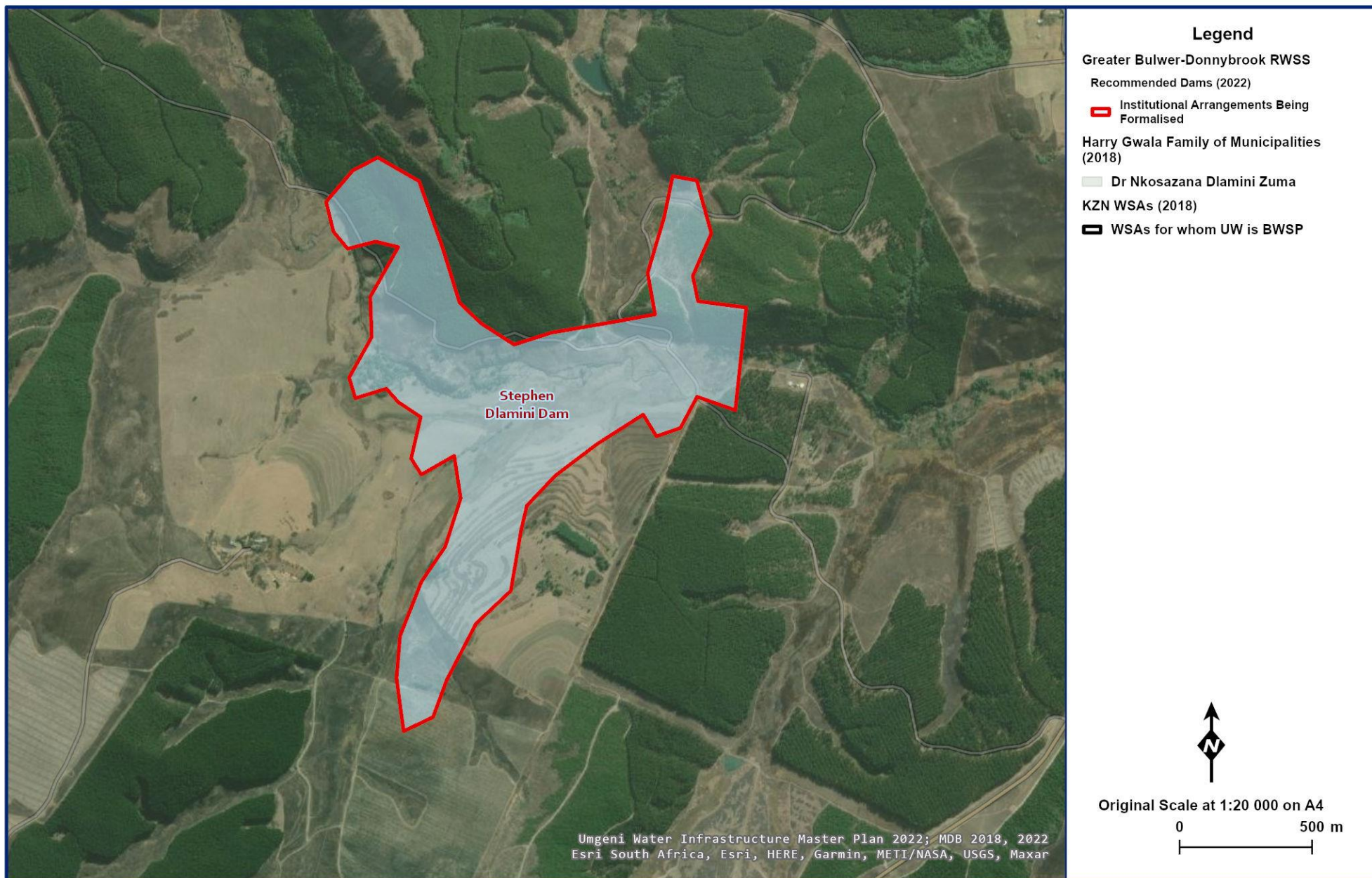

Figure 8.15 Layout of the Stephen Dlamini Dam.

REFERENCES

uMngeni-uThukela Water. 2018. uMzimkhulu Regional Bulk Water Supply Scheme Detailed Feasibility Report. Prepared by ENV Africa Consulting Services (Pty) Ltd. Pietermaritzburg.

DWS - Harry Gwala District Municipality Regional Bulk Water Supply Scheme: Due Diligence Assessment Report Of The Planning Reports For The Proposed Stephen Dlamini Dam (Final) Reference: 14/2/U100/18/1 (July 2018)

ECA and Imvula Engineers: *Stephen Dlamini Dam: Water Treatment Works Project Technical Design Report (October 2017)*

Power Point Presentation: Stakeholder Engagement between the Executive of UUW and Political Leadership of HGDM (January 2020)

DWS, 2018. *Preliminary Reserve Determination And Ecological Catergorisation Undertaken For The Protection Of The Xobho River In Quaternary Catchment U10K, Pongola To uMzimkhulu Water Management Area (WMA4)*, s.l.: Department of Water and Sanitation.

DWS, 2018. *Reserve Determination of Water Resources for the Mvoti to uMzimkhulu Catchments.*, Pretoria, South Africa: Government Gazette No.1097. Department of Water and Sanitation.

DWS, 2022. *Water Supply and Drought Operating Rules for Ixopo Water Supply System*, South Africa: Department of Water and Sanitation.

UW, 2021. *Home Farm Dam Water Resources Yield Analysis*, Pietermaritzburg: Umgeni Water.

Umgeni Water. 2023. *Ixopo Golf Course Production Borehole: Results of test pumping-summary and recommendations*

9. UPPER uMZIMKHULU SYSTEM

9.1 Synopsis of the Upper uMzimkhulu System

The Upper uMzimkhulu Region consists of the uMzimkhulu River catchment from its headwaters in the Drakensberg to the Ibis-uMzimkhulu confluence on the Harry Gwala-Ugu municipal boundary. Settlements in the Upper uMzimkhulu include Himeville, Underberg and Creighton in the Dr Nkosazana-Dlamini Local Municipality and the town of Mzimkhulu in the Mzimkhulu Local Municipality. The Underberg WTP supplies Underberg and Himeville and the uMzimkhulu WTP supplies the Mzimkhulu town and surrounding areas (**Figure 9.1**, **Figure 9.2** and **Figure 9.3**).

The uMzimkhulu River (great home of all rivers) rises in the Ukhahlamba Drakensberg Park (Garden Castle Forest) at a height of just over 3 000 m above sea level in the upper part of Quaternary Catchment T51A and flows south-easterly towards the Indian Ocean. The Mlambonja and Mzimkhulwana Rivers join the uMzimkhulu River, after which it flows south of the town of Underberg and is later joined by the Pholela and Ngwangwane Rivers.

The upper part of the catchment is characterised by agricultural development, mainly under irrigation and fed by numerous farm dams. The area is serviced by the farming towns of Underberg, Himeville, Creighton and Harding, which have reasonable water supply infrastructure. Tourism also plays a large role in the upper catchment, where there are numerous resorts and hotels, many with dams offering boating, trout fishing, hiking, mountaineering, horse riding and golf.

Some 800 km² of the upper catchment and upper reaches of the tributaries have been afforested. The uMzimkhulu River then flows past the northern and eastern sides of the town of Umzimkulu. The town of Mzimkhulu is situated in the flood plain of the river and is subject to periodic flooding. This part of the catchment is predominantly rural tribal trust land and formed part of the previously independent Transkei. In this area, there are scattered subsistence rural communities drawing water from run-of-river schemes. In the middle reaches, there are a number of rural water supply schemes, drawing water mostly from local streams, but also from boreholes and springs. The river then enters a deep gorge, where it is joined by the Bisi River below Mzimkhulu town.

uMngeni-uThukela Water currently does not own or operate infrastructure in the Upper uMzimkhulu region.

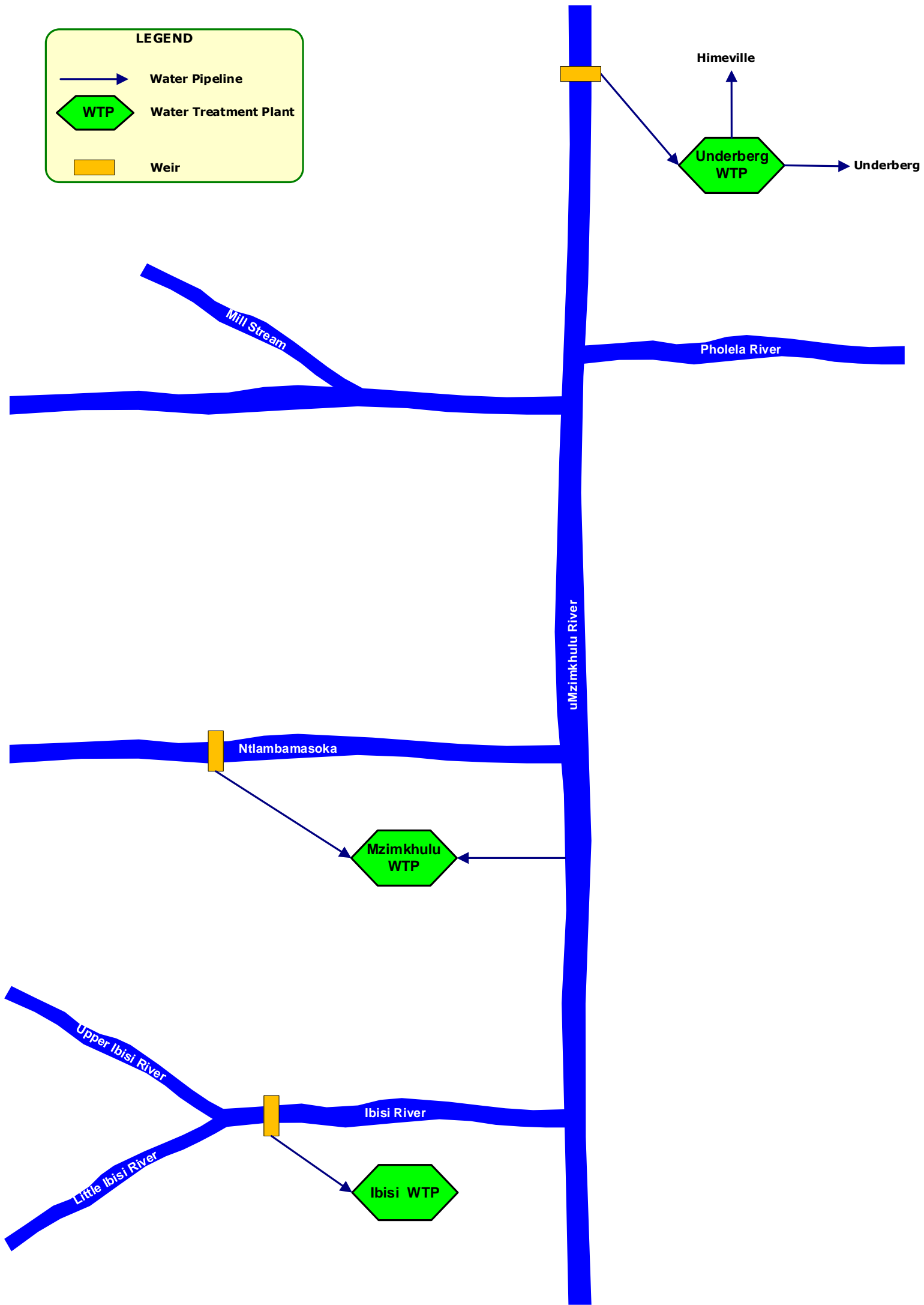

Figure 9.1 Schematic of the Upper Mzimkhulu River System

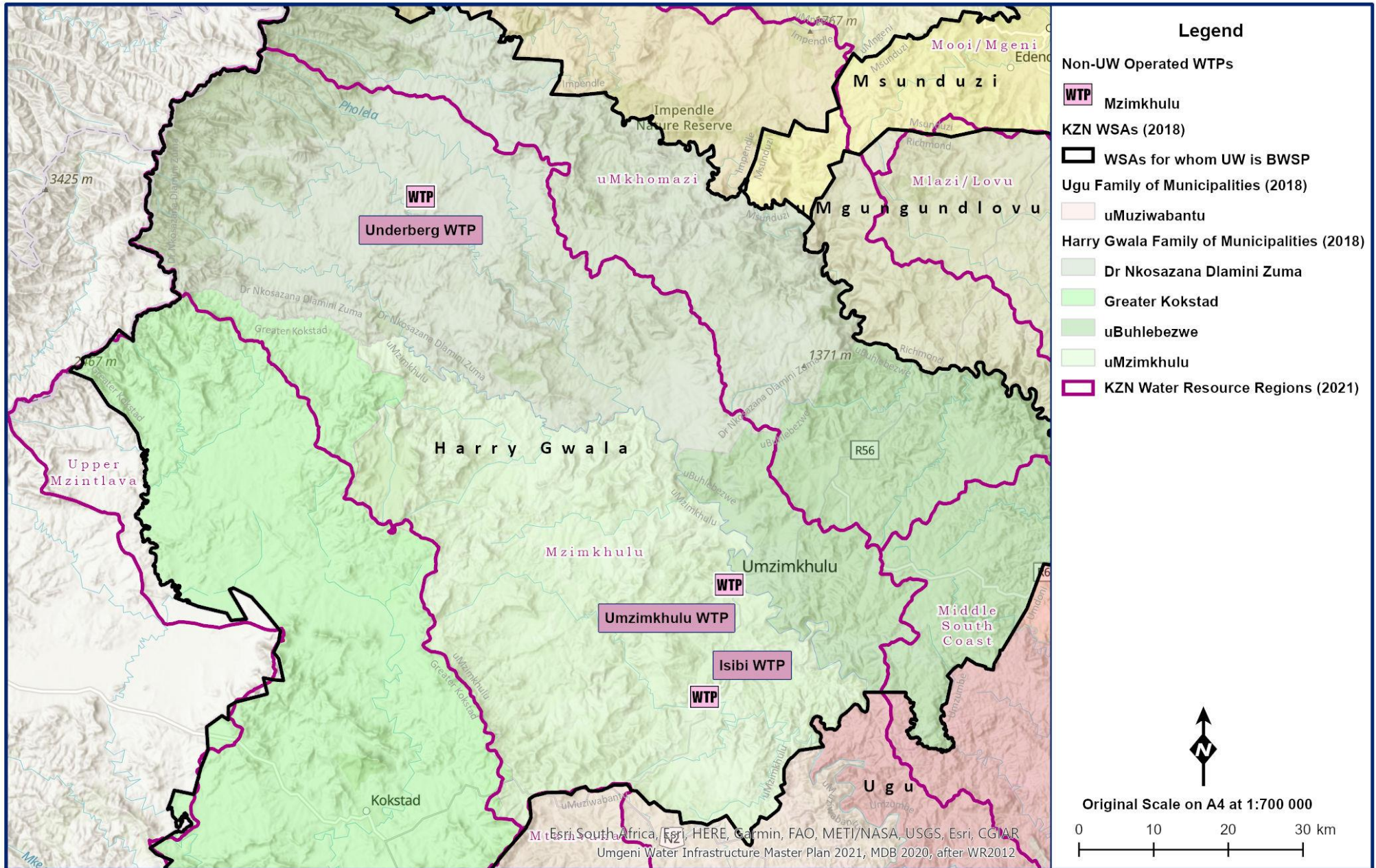

Figure 9.2 General layout of the Upper Mzimkhulu System.

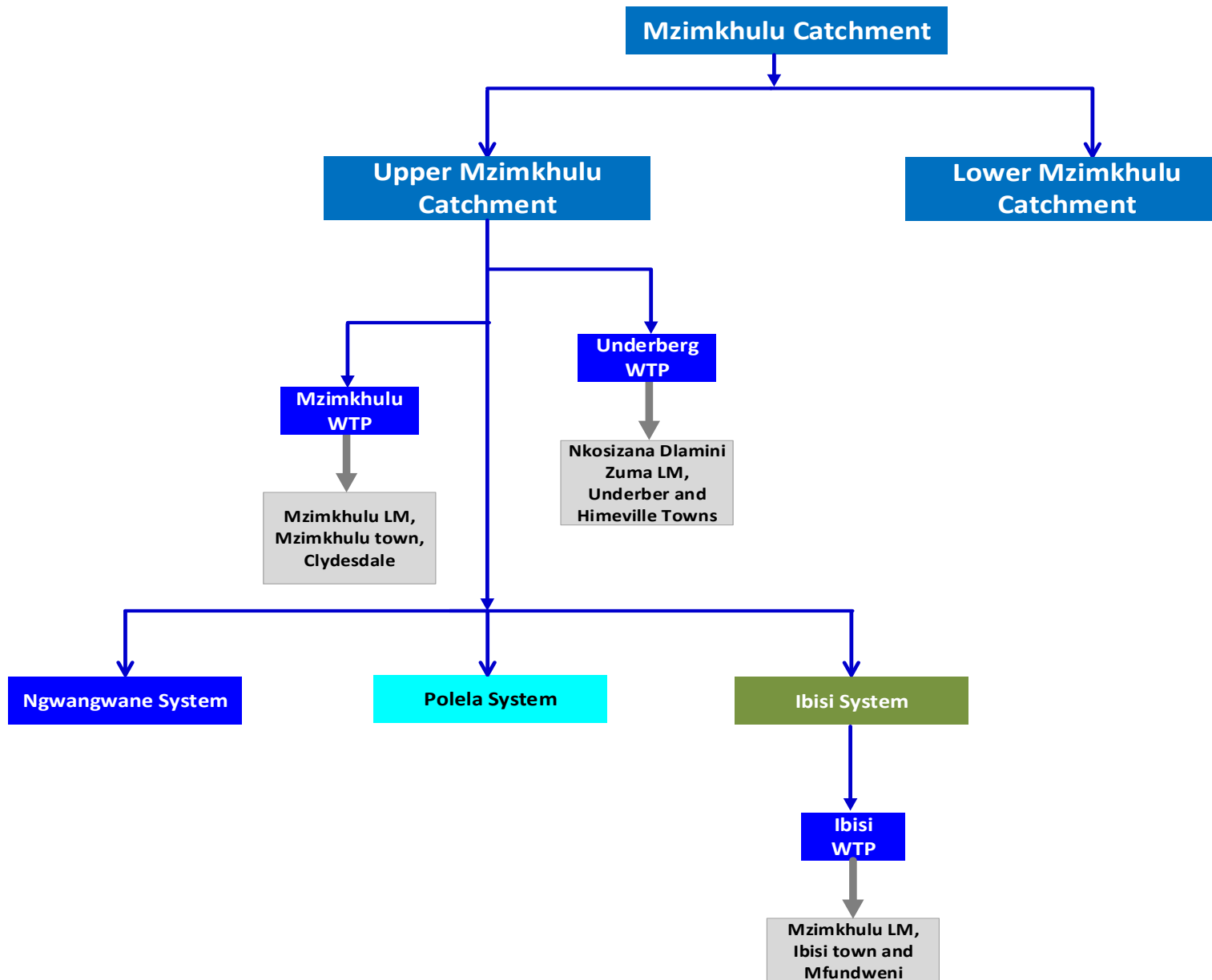

Figure 9.3 Network diagram of the Upper uMzimkhulu System

9.2 Water Resources of the Upper uMzimkhulu System

9.2.1 Description of the Upper uMzimkhulu System Water Resource Region

Please refer to **Section 11.2.1 (d) in Volume 4** for the description of the uMzimkhulu Water Resource Region.

(a) Overview

The general land use in the catchment includes irrigated agriculture, wetlands, urban/built environment and farm dams. There are also areas in the catchment with irrigated pastures, citrus and potatoes as the predominant crop types. The stream flow reduction activities found in the catchment include plantation forestry, alien vegetation and dryland sugarcane. These land use activities reduce the natural runoff, before other water users in the catchment can make use of it.

The major tributaries of the uMzimkhulu River include the following:

- Ngwangwane River, which is situated in the upper uMzimkhulu River on the right bank. It confluences with the uMzimkhulu River at the outlet of quaternary catchment T51C.
- The Pholela River, which is situated on the left bank of the uMzimkhulu River. It also confluences with the uMzimkhulu River in the quaternary catchment T51C
- The Bisi River, which is located on the right bank of uMzimkhulu River, confluences the uMzimkhulu River on the municipal boundary of Harry Gwala and Ugu District Municipality at the outlet of quaternary catchment T52H.

(b) Surface Water

The hydrological characteristics of the Upper uMzimkhulu Region are presented in **Table 9.1** as can be expected, the higher rainfall zones are those in the higher altitude areas of the Drakensberg Mountains with a MAP exceeding 1200mm in some of these zones. Evaporation is considered relatively high throughout the region with in excess of 1300mm being prevalent in some of the areas.

Table 9.1 Upper uMzimkhulu Region Hydrological Characteristics (WR2012: Mvoti to uMzimkhulu Quat Info WMA 11 7Jul2015 spreadsheet).

Region	River (Catchment)	Area (km ²)	Annual Average			
			Evaporation (mm)	Rainfall (mm)	Natural Runoff (million m ³ /annum)	Natural Runoff (mm)
Upper uMzimkhulu	T51A	328	1300	1260	155.9	475.3
	T51B	210	1300	1180	86.8	413.3
	T51C	462	1300	952	119.9	259.5
	T51D	142	1300	1234	63.5	447.2
	T51E	256	1300	957	61.1	238.7
	T51F	307	1350	1142	114.0	371.3
	T51G	256	1350	1087	89.3	348.8
	T51H	520	1300	947	125.8	241.9
	T51J	265	1300	912	54.6	206.0
	T52A	382	1200	906	127.3	333.2
	T52B	256	1200	881	30.9	120.7
	T52C	261	1200	836	58.4	223.8
	T52D	531	1200	791	52.7	99.3
	T52E	233	1200	903	43.9	188.4
	T52F	418	1200	908	75.0	179.4
	T52G	221	1200	903	51.2	231.7
	T52H	344	1200	778	62.3	181.1
	Total	5392				

9.2.2 Reserve

Please refer to **Section 11.2.2 (d) in Volume 4** for the uMzimkhulu Water Resource Region Reserve information.

The overall state of the ecosystem in this catchment, including the estuary, is generally good and the river is fairly resilient to some additional development in the catchment. The PES of most rivers in the Upper uMzimkhulu Water Resource Region, published in gazette No. 1097, is category B although the PES for Ngwangwane and Boesmans River is category A, characterised by an unmodified and near natural state (DWA, 2016). The study did not find any riverine water quality hotspots in this catchment area. The only impacts found were on the estuary in Port Shepstone and Mzimkhulu Sugar Mill and nothing on the riverine component. The RECs and TECs for rivers in this region are further defined in the gazette.

9.2.3 Existing Water Resource Infrastructure and Yields

The Underberg WTP, uMzimkhulu WTP and Ibisi WTP rely on run-of-river abstractions. There are two key flow gauges in the Upper uMzimkhulu Catchment (T5H004 and T5H005) located in the uMzimkhulu River in T51B and Nkonzo River in T52A, respectively. These stations generally have long records with good quality data. Low flows generally occur in winter months and during this period,

water supply to communities from natural sources like streams and rivers becomes difficult. However, water supply for the communities is adequate in the summer months.

The storage regulation in this region is low and the only dams in the area include a number of small farm dams in tributaries and instream dams. Point source abstractions from the Upper uMzimkhulu River and its tributaries mainly supply commercial, industrial and domestic demands in rural areas and towns such as Underberg, Himeville, and Creighton. The section of the river near Mzimkhulu Town is prone to flooding with some flow gauges having been washed away in the past. Groundwater use in the catchment is generally not registered and there are no yield estimates available for boreholes linked to the water supply system. However, it is estimated that there are relatively high groundwater volumes being abstracted for domestic water use, as there are a number of standalone schemes, which are dependent on the groundwater systems.

DWS has identified potential augmentation options to address the current and future water supply shortages. One of the options is to develop dams and / or weirs in the Ngwangwane River and Bisi River (tributaries of the uMzimkhulu River) to improve the reliability of the raw water (DWS, 2016). By providing storage, the impacts of significant increases in the areas of plantation forestry and increased irrigation, would not only be successfully mitigated, but the state of the river could be improved to fully meet the EWRs (DWA, 2011).

9.2.4 Operating Rules

There are no operating rules as the Underberg WTP, uMzimkhulu WTP and Ibisi WTP rely on run-of-river abstractions.

9.3 Supply Systems

9.3.1 Description of the Upper uMzimkhulu System

There are numerous smaller water treatment plants in the Upper uMzimkhulu System but for the purpose of this report, focus is on the plants that have a capacity of 2 Mℓ/day and greater.

Brief description (locality and supply area) of the primary bulk WTP's within the Upper uMzimkhulu System:

- a) **Underberg WTP:** Underberg is a small town located at the foothills of the Southern Drakensberg approximately 130 km from Pietermaritzburg in KwaZulu-Natal. The town functions mainly as a tourist centre for the uKhahlamba-Drakensberg Park, which has recently been declared as a World Heritage site. Underberg also functions as a service centre for the surrounding farming and rural areas.

The raw water supply source to the Underberg WTP is the uMzimkhulu River and the scheme supplies potable water to the towns of Underberg and Himeville. The treatment works is classified as class D.

- b) **uMzimkhulu WTP:** The uMzimkhulu Water Treatment Plant is situated in the town of Mzimkhulu approximately 30 km SW of Ixopo as the crow flies; off the R56 and half the way to Kokstad from Ixopo.

The Umzimkulu Town depends on raw water supplies from the uMzimkhulu River as its source. Raw water gravitates to a pump station near the uMzimkhulu River. It is then pumped from the raw water pumping station to the Umzimkulu Town WTP which is located near the town and where it is treated to potable standards. Potable water is supplied to the town and surrounding areas. This treatment works is classified as class C.

Ibisi WTP: The Ibisi Water Treatment Plant is situated near Wasbank and approximately 15 km southwest of Mzimkhulu as the crow flies (off the R56 and two thirds of the way to Kokstad from Ixopo). The town of Ibisi and surrounding areas are currently supplied with potable water from the treatment works located within the town. Water is abstracted from the Ibisi River and pumped to the WTP. Potable water from the WTP is pumped to the network. The design capacity of the plant is approximately 2 Mℓ/day (still to be verified through a process survey). This treatment works is classified as class C.

More detailed information on the WTP and system follow in the next section.

(c) Underberg Water Treatment Plant and Supply System

The primary source of raw water for the Underberg WTP (**Figure 9.1, Table 9.2**) is the uMzimkhulu River. Raw water is gravity fed to a pump station located 0.4 km from the weir and then conveyed to the water treatment plant towards the east of the town. Treated water is then supplied to Underberg and the town of Himeville, which is located approximately 4 km to the north.

The Underberg WTP, a Class D plant, operates 24 hours a day. The plant is operated and maintained by Harry Gwala District Municipality.

The capacity of the filters is about 5.2 Mℓ/day whereas the clarifiers are limited to 4.3 Mℓ/day. The works is therefore rated on the latter figure. The Underberg WTP has been upgraded from 3.6 Mℓ/day to its current capacity but the current usage cannot be verified at this stage due to the lack of metering on the plant.

Table 9.2 Characteristics of the Underberg WTP

WTP Name:	Underberg WTP
System:	uMzimkhulu River System
Maximum Design Capacity:	5 Mℓ/day (approximately)
Current Utilisation:	2.085 Mℓ/day (as per HGDM, July 2023)
Raw Water Storage Capacity:	2.5 Mℓ raw water reservoir at pump station
Raw Water Supply Capacity:	The yield of the uMzimkhulu river at the abstraction is unknown although the yield of the uMzimkhulu should be adequate for the short to medium-term demand. The gravity pipeline from the weir can deliver 13.47 Mℓ/day. The pump station can deliver 3.6 Mℓ/day while the rising main can deliver 2.29 to 4 Mℓ/day.
Pre-Oxidation Type:	None
Primary Water Pre-Treatment Chemical:	Polyelectrolyte coagulant Wetfloc 7523
Total Coagulant Dosing Capacity:	7.6 ℓ/h*
Rapid Mixing Method:	Flash Mixing via a weir
Clarifier Type:	Pulsator type clarifiers
Number of Clarifiers:	2 rectangular
Total Area of all Clarifiers:	128 m ²
Total Capacity of Clarifiers:	4.3 Mℓ/day
Filter Type:	Pressure Filters
Number of Filters:	2
Filter Floor Type	N/A
Total Filtration Area of all Filters	31.8 m ²
Total Filtration Design Capacity of all Filters:	5.25 Mℓ/day
Average Recovery Backwash water volume:	Operator could not confirm
Total Capacity of backwash Clarifier:	100 m ³
Capacity of Used Wash Water System:	Operator could not confirm
Primary Post Disinfection Type:	Chlorination (chlorine gas)
Disinfection Dosing Capacity:	3 kg/d
Disinfectant Storage Capacity:	70kg cylinder
Total Treated Water Storage Capacity:	3.75 Mℓ

*Assumed

Raw water infrastructure for the source of the Underberg WTP is summarised in **Table 9.3**.

- **Abstraction Weir, Pump station and Pipeline:** A 1.5m high mass concrete weir diverts river water into a 315mm diameter uPVC pipeline that gravitates water to a raw water reservoir. Water is then pumped from the raw water reservoir to the head of the treatment plant that is situated to the east of the town.

The raw water rising main is a combination of steel and uPVC pipework (**Table 9.4**) that varies in diameter from 160mm to 200mm. No information is available as to the lengths of the different sections and sections of the steel pipeline are above ground in the steep rock face along the pipeline route. The limiting factor for the capacity of the rising main would be the smallest diameter pipeline and that is the 160mm diameter uPVC pipeline.

A project is underway to replace the rising main with a 250mm diameter steel pipeline. A portion of the pipeline has been replaced from the new pump station to meet the existing rising main before the river crossing.

Table 9.3 Pump Station Details: Underberg System, uMzimkhulu River (weir), Raw Water

System	Pump Station Name	Pump Status		Pump Description	Supply From	Supply To	Static Head (m)	Duty Head (m)	Duty Capacity (Mℓ/day)	Approx. Age	Approx. Condition
		Duty	Stand by								
Underberg	Underberg Raw Water Pump Station	2	1	Vertical Turbine (130 kW)	uMzimkhulu Weir	Underberg WTP	166	170	3.6	4	Good

Table 9.4 Pipeline Details: Underberg System, Raw Water Supply Pipelines

System	Pipeline Name	From	To	Length (km)	Nominal Diameter (mm)	Material	Capacity (Mℓ/day)	Age (years)
Underberg	Underberg Raw Water Gravity	uMzimkhulu Weir	Underberg Raw Water Pump Station	0.5	315	uPVC	10.1	25
Underberg	Underberg Raw Water Rising Main	Underberg Raw Water Pump Station	Underberg WTP	1.54	150-200	uPVC/Steel	3.05	20

Potable water supply system

Potable water from the Underberg WTP supplies two towns through a series of pipelines (**Table 9.5**) and reservoirs (**Table 9.6**) i.e. Underberg and the town of Himeville (**Figure 9.4**). Interaction with the relevant area manager of Harry Gwala DM and information received from PSP's indicate the following:

The upgrade of the water treatment plant, to date, included the following:

- A second water filtration plant
- Reservoir bypass facility
- Extended holding capacity of the raw water inlet
- Safe chlorine gas storage and operational facility
- Completion of water treatment plant upgrade including the provision of sludge drying beds and a facility to recycle backwash water.
- The construction of a new reservoir providing 48hr storage.

The potable water is stored on site in three reservoirs with varying capacities. The two square/rectangular reservoirs are interconnected and the top water levels could not be obtained. The smaller circular reservoir supplies the surrounding high lying areas. The details of the reservoirs are found in **Table 9.6**.

The potable supply to the Underberg Town and Himeville is via a 200mm diameter uPVC gravity pipeline and this branches out into two 110mm diameter pipelines. One feeds the north-western portion of the town and the other is a dedicated pipeline to the town of Himeville to the north.

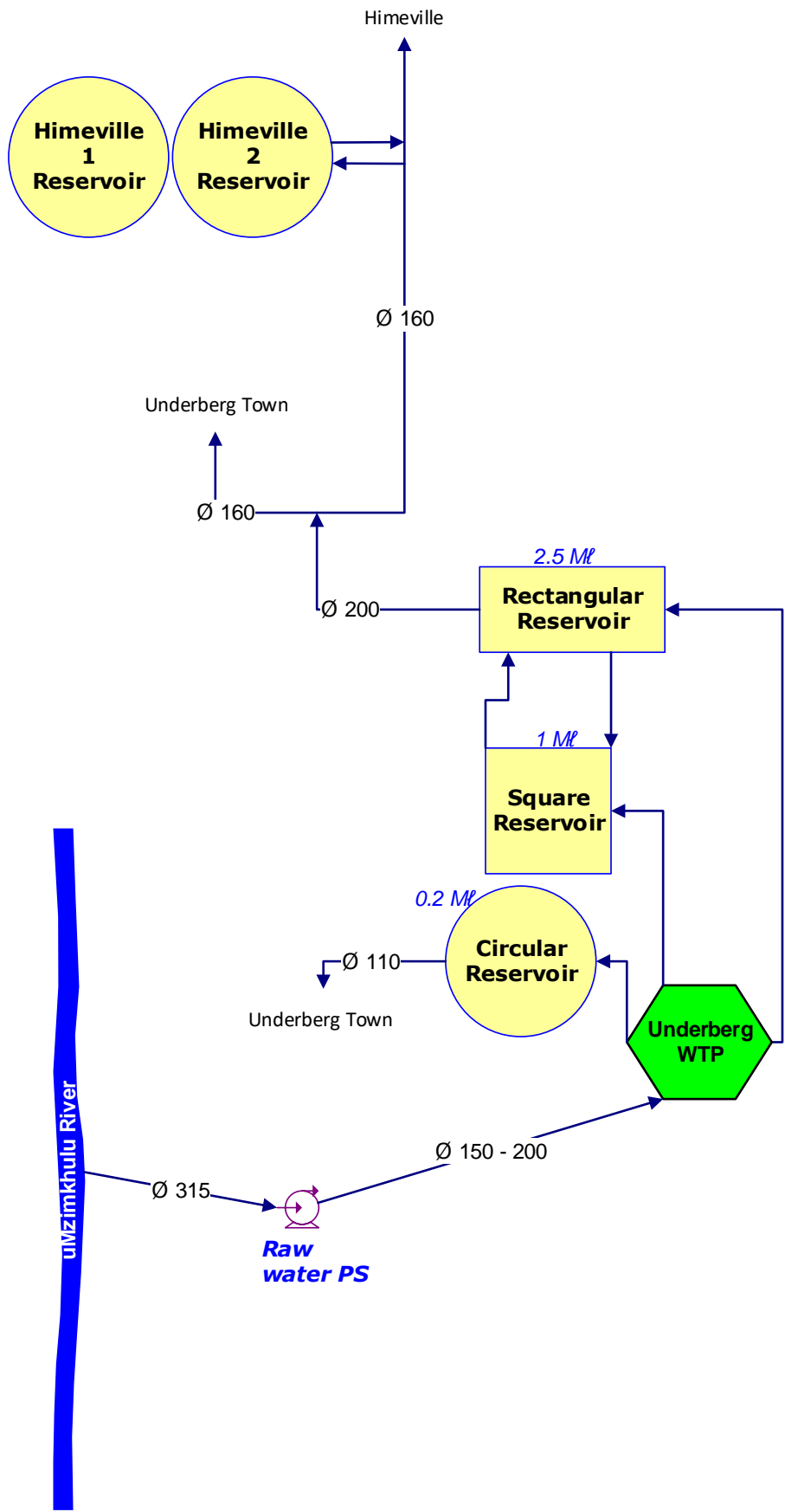

Figure 9.4 Schematic of the Underberg System

Table 9.5 Pipeline Details: Underberg Potable Supply Pipelines

System	Pipeline Name	From	To	Length (km)	Nominal Diameter (mm)	Material	Capacity * (Mℓ/day)	Age (years)
Underberg	Underberg/Himeville	Underberg WTP	Underberg/ Himeville	1.3	200	uPVC	4.07	20
Underberg	Underberg	Underberg WTP	Underberg Town	2	160	uPVC	2.61	12
Underberg	Himeville	Underberg WTP	Himeville Town/reservoirs	2.7	160	uPVC	2.61	20

*Capacity based on velocity of 1.5m/s

Table 9.6 Reservoir Details: Underberg System

System	Reservoir Site	Reservoir Name	Capacity (Mℓ)	Reservoir Function	TWL (m ASL)	FL (m ASL)
Underberg WTP	Underberg WTP	Rectangular	2.5	Terminal	1609.95	1605.76
Underberg WTP	Underberg WTP	Square	1.0	Bulk	1610.15	1606.40
Underberg WTP	Underberg WTP	Circular	0.25	Terminal	1610.15	1608.62
Underberg WTP	Himeville	Himeville 1	0.2	Bulk	1579.82*	1575*
Underberg WTP	Himeville	Himeville 2	0.2	Terminal	1579.82*	1575*

*From measurement on Google Earth

(d) uMzimkhulu Water Treatment Plant and Supply System

Mzimkhulu is a town in Harry Gwala District Municipality in KwaZulu-Natal. The town lies 243 km north-east of Mthatha and 18 km south-west of Ixopo. It developed from a trading-post and was laid out in 1884. The town name originates from the uMzimkhulu River on which it is situated. (Wikipedia).

Mzimkhulu town and its surrounding is currently supplied with potable water from a WTP (**Figure 9.5, Table 9.7**) located within the town. Raw water is pumped from the uMzimkhulu River to the WTP. Water is also gravity fed from a tributary north of the town into the WTP. From the WTP, water is distributed into the reticulation networks supplying the town and surrounding areas.

The design capacity of the conventional plant is 3 Mℓ/day and the design capacity of the package plant is 2 Mℓ/day. This treatment works is classified as class C. This plant is a two shift plant and is operated 24 hours a day. 1 x class V Superintendent, 1 x class II Process Controller, 4 x class 0 Process Controllers and 2 x General Assistants.



Figure 9.5 Pictorial view of the uMzimkhulu WTP

Table 9.7 Characteristics of the uMzimkhulu WTP

WTP Name:	uMzimkhulu WTP
System:	uMzimkhulu River System
Maximum Design Capacity:	5 Mℓ/day
Current Utilisation:	6.07 Mℓ/day (as per July 2023, HDGM)
Raw Water Storage Capacity:	No Raw Water Storage
Raw Water Supply Capacity:	The gravity pipeline from the weir can deliver 4.07 Mℓ/day. The pump station can deliver 2.4 Mℓ/day while the rising main can deliver 12.8 Mℓ/day.
Pre-Oxidation Type:	None
Primary Water Pre-Treatment Chemical:	Wetfloc 1723
Total Coagulant Dosing Capacity:	12 ℓ/h
Rapid Mixing Method:	Flash Mixing
Clarifier Type:	Sedimentation tanks and lamella
Number of Clarifiers:	3 (package Plant) and 2 (conventional Plant)
Total Area of all Clarifiers:	78 m ² (traditional Plant), 39,6 m ² (lamella on package plant)
Total Capacity of Clarifiers:	5.26 Mℓ/d
Filter Type:	Pressure Filters
Number of Filters:	2 (conventional plant) and 3 (package plant)
Filter Floor Type	False floor*
Total Filtration Area of all Filters	8.31 m ² on conventional plant and 11.4 m ² on package plant – 19.71 m ² in total
Total Filtration Design Capacity of all Filters:	3.25 Mℓ/d
Average Recovery Backwash water volume:	Pumps not operational – no volumes recorded
Total Capacity of backwash Clarifier:	N/A
Capacity of Used Wash Water System:	Operator could not confirm
Primary Post Disinfection Type:	Sodium Hypochlorite
Disinfection Dosing Capacity:	30 ℓ/h
Disinfectant Storage Capacity:	3 Months supply available on site
Total Treated Water Storage Capacity:	2 Mℓ

*Assumed as operator could not confirm

The uMzimkhulu WTP derives its raw water from two sources. A gravity main from the Ntlambamasoka stream, which is a tributary of the uMzimkhulu River and flows directly to the uMzimkhulu WTP, and a raw water pumping system that pumps water directly from the uMzimkhulu River to the uMzimkhulu WTP.

Raw water infrastructure for the sources of the uMzimkhulu WTP are summarised below and in **Table 9.8** and **Table 9.9**.

- **Abstraction Weir and Pipeline:** A concrete weir diverts river water into a 200mm diameter uPVC pipeline that gravitates water to the head of works at uMzimkhulu WTP. No hydrological information is available to confirm the reliability of the source to meet future demands. Water is currently supplied by use of one gravity pipeline. The other line, a 100mm diameter AC pipeline, is reportedly disused.
- **Pump Station and Pipeline:** Water is abstracted from the uMzimkhulu River by means of a weir and a raw water pumping main from the uMzimkhulu River to the Waterworks. A number of hydrological studies have been undertaken for the uMzimkhulu River which confirm that it will meet the demands of Mzimkhulu and Clydesdale. There has been an upgrade of the uMzimkhulu abstraction facility although no information is available to UuW by the DM at the time of this report.

Table 9.8 Pump Station Details: uMzimkhulu River (weir), Raw Water

System	Pump Station Name	Pump Status		Pump Description	Supply From	Supply To	Static Head (m)	Duty Head (m)	Duty Capacity (Mℓ/day)	Approx. Age	Approx. Condition
		Duty	Stand by								
uMzimkhulu	uMzimkhulu Raw Water Pump Station	2	1	Etanorm, 270mm Dia, 125-100/315-2P, 90kw RPM=2960 V=400	uMzimkhulu Weir	uMzimkhulu WTP	65	70	2.4	31*	Fair

*Source: process controller; HG DM staff

Table 9.9 Pipeline Details: uMzimkhulu System, Raw Water Supply Pipelines

System	Pipeline Name	From	To	Length (km)	Nominal Diameter (mm)	Material	Capacity * (Mℓ/day)	Age (years)
uMzimkhulu	Ntlambamasoka Raw Water Gravity	uMzimkhulu Weir	uMzimkhulu WTP	3.85	200	uPVC	4.07	39#
uMzimkhulu	uMzimkhulu Raw Water Rising Main	uMzimkhulu Raw Water Pump Station	uMzimkhulu WTP	2.15	355	uPVC	3.05	31#

#Source: process controller; HG DM staff

* Capacity based on velocity of 1.5m/s

Potable water supply system

Water Treatment Plants

There are two separate plants at the site including the original concrete works and a newly built package plant. The old works consists of a chemical dosing room with raw water inlet and rapid mixing chamber, flocculation channels and a clarifier. The plant also includes three old sand filters that are being used as balancing tanks, two pressure filters, clear water reservoir, chlorine dosing room, high lift pump station (**Table 9.11**), sludge dams and return pump station and staff accommodation. The package plant consists of two lamella clarifiers, a pre-fabricated flocculation column and balancing tank, three pressure filters and a chemical dosing room. The design capacity of the original works and package plant has been reported to be 2.0 Mℓ/day and 3.0 Mℓ/day respectively. The combined design capacity is thus 5.0 Mℓ/day. However, the limiting factor for the plant is the capacity of the filters which have a combined capacity of 3.25 Mℓ/day. The current plant usage is unknown as there is no accurate metering on site and no previous records to consult.

Water Supply System

Potable water from the uMzimkhulu WTP is fed into three clear water reservoirs situated at the works, two circular 1 Mℓ concrete reservoirs and a 0.25 Mℓ circular brick structure. The 0.25 Mℓ brick

structure has been abandoned and is no longer in use. Potable water from one of the 1 Mℓ structure is distributed to Isisulu, Mzimkhulu town and the college via a 160mm uPVC diameter gravity main which in turn feeds the reticulation systems (**Figure 9.1**).

The two by 1 Mℓ reservoirs at the works gravity feed water to a pump station located at the works and potable water is pumped to two high level reservoirs. The first reservoir is a 0.25 Mℓ circular concrete reservoir and is located 250m from the plant and approximately 30m above the works. The second reservoir is a 1 Mℓ circular concrete reservoir located 500m from the WTP and approximately 65m above the works. A 160mm diameter uPVC pipeline (**Table 9.10**) delivers potable water to both reservoirs. The smaller 0.25 kℓ high level reservoir (**Table 9.12**) supplies water to the hospital reservoirs via a 160mm diameter uPVC pipeline with a 110mm diameter uPVC branch pipeline to Extension 6 and 8. Potable water from the 1 Mℓ High Level Reservoir supplies water to Clydesdale Reservoirs via a 200mm diameter uPVC pipeline. These reservoirs supply the settlement of Clydesdale and surrounding areas. A 160mm diameter uPVC branch pipeline from the Clydesdale pipeline supplies the settlement of Mbizweni.

The volumes supplied to the different areas could not be determined. The condition and age of certain infrastructure could not be determined from the infrastructure owner.

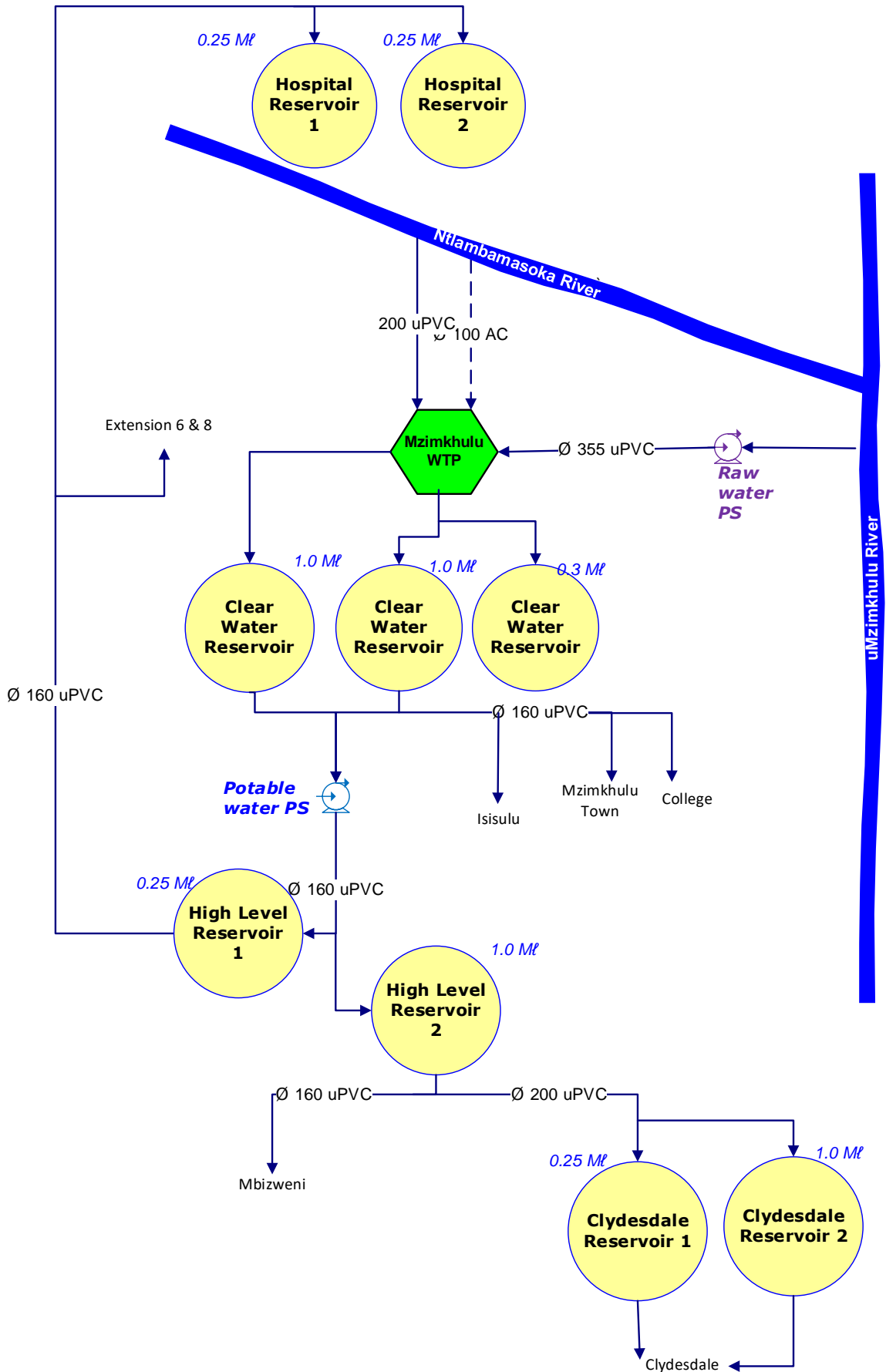

Figure 9.6 Schematic of the uMzimkhulu System

Table 9.10 Pipeline Details: uMzimkhulu Potable Supply Pipelines

System	Pipeline Name	From	To	Length (km)	Nominal Diameter (mm)	Material	Capacity * (Mℓ/day)	Age (years)
uMzimkhulu	Hospital Pipeline	uMzimkhulu WTP	Hospital Reservoirs	4.0	160	uPVC	2.61	21
uMzimkhulu	High level Rising Main	uMzimkhulu WTP	High Level Reservoirs	0.5	160	uPVC	2.61	11
uMzimkhulu	Clydesdale	High Level Reservoir 2	Clydesdale Reservoirs	2.57	200	uPVC	4.07	8

* Capacity based on velocity of 1.5m/s

Table 9.11 Pump Details: uMzimkhulu Potable Water Pump Station

System	Pump Station Name	Pump Status		Pump Description	Supply From	Supply To	Static Head (m)	Duty Head (m)	Duty Capacity (Mℓ/day)	Approx. Age	Approx. Condition
		Duty	Stand by								
uMzimkhulu	uMzimkhulu Potable WTP	2	1	1,84kw 1450RPM 174mm Dia Impeller, KSB	uMzimkhulu WTP	High Level Reservoir 1 & 2	65	135.5	4.32	5	Good

Table 9.12 Reservoir Details: uMzimkhulu System

System	Reservoir Site	Reservoir Name	Capacity (Mℓ)	Reservoir Function	TWL (mASL)	FL (mASL)
uMzimkhulu	uMzimkhulu WTW	Clear Water Res 1	1.0	Bulk	794.81	791.92*
uMzimkhulu	uMzimkhulu WTW	Clear Water Res 2	1.0	Bulk	794.81	791.92*
uMzimkhulu	uMzimkhulu WTW	Clear Water Res Brick	0.25	Bulk	798.51	797.00*
uMzimkhulu	High Level 1	High Level Reservoir 1	0.25	Bulk	838.00	836.00*
uMzimkhulu	High Level 2	High Level Reservoir 2	1.0	Bulk	869.50	867.00*
uMzimkhulu	Hospital	Hospital Reservoir 1	1.0	Terminal	809.15	806.00*
uMzimkhulu	Hospital	Hospital Reservoir 2	1.0	Terminal	809.15	806.00*
uMzimkhulu	Clydesdale	Clydesdale Reservoir 1	0.5	Terminal	856.50	854.00*
uMzimkhulu	Clydesdale	Clydesdale Reservoir 2	0.25	Terminal	850.76	846.00.*

*From measurements on Google Earth

(e) Ibisi Water Treatment Plant and Supply System

Located within Ward 11 of Mzimkhulu Local Municipality, the Ibisi Township is situated 23km south-west of Mzimkhulu town centre, and 90km north of Kokstad.

Ibisi WTP (**Figure 9.7, Table 9.13**) draws raw water from the Ibisi River and supplies the town and surrounding areas with potable water. Water is pumped to the treatment works and supplies high lying command reservoirs and then is distributed to three supply areas.

The design capacity of the plant could not be ascertained and there are conflicting reports as to the size of the plant. Indication from the DM suggests that the plant supplies 4 Mℓ /day (HGDM Staff, 2020) though consultation with the process controller and reports suggest that the plant has a 2.0 Mℓ /day capacity (UAP Ph3 2020).



Figure 9.7 Pictorial View of the Ibisi WTP

Table 9.13 Characteristics of the Ibisi WTP

WTP Name:	Ibisi WTP
System:	Ibisi River System
Maximum Design Capacity:	2.0 Mℓ/day*
Current Utilisation:	2.0 Mℓ/day* (no updated information available)
Raw Water Storage Capacity:	No Raw Water Storage on site
Raw Water Supply Capacity:	Raw Water Pumps are submersible pumps that could not be accessed to inspect. The raw water pumping main is a 160 PVC pipeline with a capacity of 2.6 Mℓ/day.
Pre-Oxidation Type:	None*
Primary Water Pre-Treatment Chemical:	Polyelectrolyte Coagulant Wetfloc 7523
Total Coagulant Dosing Capacity:	7.6 ℓ/h*
Rapid Mixing Method:	Flash Mixing
Clarifier Type:	Lamella*
Number of Clarifiers:	3
Total Area of all Clarifiers:	33.75 m ²
Total Capacity of Clarifiers:	1.85 Mℓ/d
Filter Type:	Pressure Filters
Number of Filters:	4
Filter Floor Type	N/A
Total Filtration Area of all Filters	12.5 m ²
Total Filtration Design Capacity of all Filters:	2.25 Mℓ/d
Average Recovery Backwash water volume:	No recovery takes place, water discharged to open field within the plant vicinity.
Total Capacity of backwash Clarifier:	N/A
Capacity of Used Wash Water System:	N/A
Primary Post Disinfection Type:	Sodium Hypochlorite
Disinfection Dosing Capacity:	15 ℓ/h
Disinfectant Storage Capacity:	38 x 25ℓ
Total Treated Water Storage Capacity:	None on site

*Source: Process Controller; HG DM staff 2020

Raw water infrastructure for the source of the Ibis WTP is summarised below and in **Table 9.14** and **Table 9.15**.

- **Abstraction weir, pump station and pipeline:** A chamber constructed in the river houses a duty and a standby submersible pump. The electrical control for the submersibles are housed in the old pump house although no lifting equipment was available at the time of inspection to confirm the size and capability of the pumps. Water is delivered to the WTP via a 160mm diameter PVC pipeline.
- The old abstraction pipeline from the river, the pump station, the pumping main and associated infrastructure are still on site although these have been abandoned. The pump station has the pumps (3), motors (3) and electrical infrastructure in place and could be used as a backup once refurbished.

Table 9.14 Pump Station Details: Ibisi River (weir), Raw Water

System	Pump Station Name	Pump Status		Pump Description	Supply From	Supply To	Static Head (m)	Duty Head (m)	Duty Capacity (Mℓ/day)	Approx. Age	Approx. Condition
		Duty	Standby								
Ibisi	Ibisi Raw Water Pump Station	1	1	Submersible 22Kw Motor	Ibisi River	Ibisi WTP	12*	15*	2.0*	<14*	Good*

**From Process Controller*

Table 9.15 Pipeline Details: Ibisi System, Raw Water Supply Pipeline

System	Pipeline Name	From	To	Length (km)	Nominal Diameter (mm)	Material	Capacity * (Mℓ/day)	Age (years)
Ibisi	Ibisi Raw Water Rising Main	Ibisi River	Ibisi WTP	370	160*	PVC*	2.6	<14*

**From Process Controller*

Potable water supply system

Water Treatment Works

An upgrade to the WTP has recently been constructed. The old plant consists of three pre-fabricated clarifiers, two pressure filters and a pump station and chemical house; the new addition consists of a lamella clarifier, two more pressure filters and a new pump station and chemical house.

Design Capacity

The design capacity is reported to be 45 m³/hr, although, it appears that this was the capacity before the upgrade. The capacity of the plant was most likely doubled by the upgrade to 90 m³/hr or roughly 2 Mℓ /day.

Water Supply System

Potable water from the Ibisi WTP is pumped (**Table 9.17**) to three high level reservoirs situated approximately 1900m from the plant at an elevation of 718m ASL (**Figure 9.8**). The raw water pipeline is a 160mm diameter mPVC. The three reservoirs are: Old Reservoir 1 (assumed 0.15Mℓ), Old Reservoir 2 (assumed 0.85Mℓ) and New Reservoir (1.3Mℓ) (**Table 9.18**). Potable water from the reservoirs discharge via a 90mm diameter PVC pipeline (**Table 9.16**) into 4 reinforced concrete tanks that then distribute water to Ibisi Township. A 110mm diameter PVC pipeline from the old reservoirs supply water to the RDP housing development across the R56. A 160mm diameter PVC pipeline from the new reservoir is also connected directly to the 110mm PVC pipeline that supplies the RDP housing.

Upon inspection of the high level reservoir site, it was discovered that the Old Reservoir 1 is disused and the roof structure has collapsed. The connection of this reservoir to the Mfundweni Pump Station

has been disconnected and supply to the pump station is from Old Reservoir 2 and the New Reservoir. The Old Reservoir 2 seems to have a leak in the base with treated water flowing in the northern side. The four reinforced concrete tanks have been abandoned and supply to them has been discontinued.

A pump station is located next to the Old Reservoir 1 and this supplies water to the Mfundweni settlement approximately 1.1km to the south via an 80mm diameter PVC pipe. Water is collected in two reservoirs at Mfundweni and is distributed to the surrounding areas. The size of these reservoirs are not known and are assumed to be 0.25Mℓ each.

At the time of writing this report, volumes supplied to the different areas could not be determined. The condition and age of certain infrastructure could also not be determined.

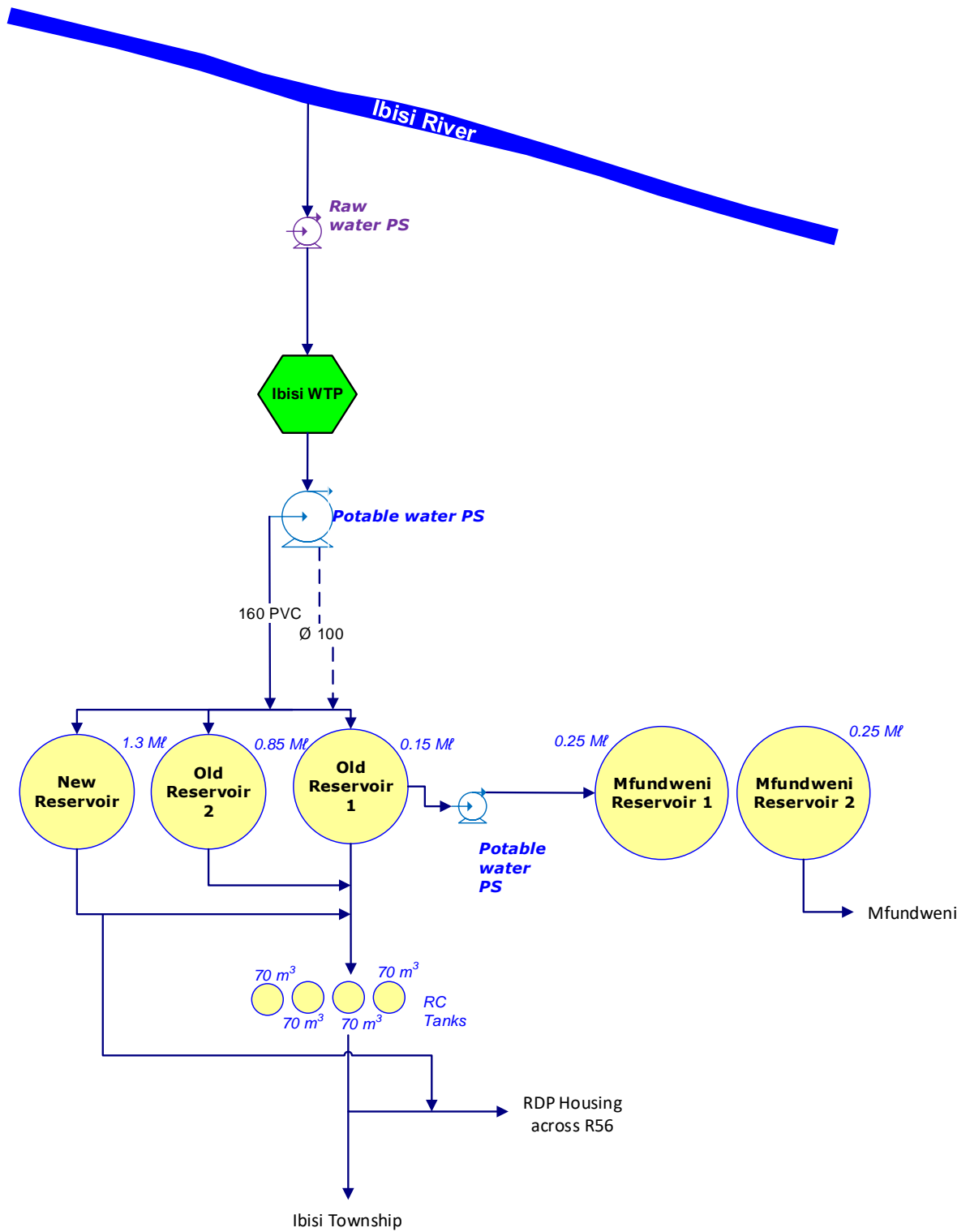

Figure 9.8 Schematic of the Ibisi BWSS

Table 9.16 Pipeline Details: Ibisi Potable Supply Pipelines

System	Pipeline Name	From	To	Length (km)	Nominal Diameter (mm)	Material	Capacity * (Mℓ/day)	Age (years)
Ibisi	High level Rising Main	Ibisi WTP	High level Reservoirs	1.9	160	uPVC	2.61	12
Ibisi	RDP Housing Pipeline	High level Reservoirs	RDP Settlement	0.655	110	uPVC	1.23	12
Ibisi	Mfundweni Rising Main	High Level Reservoir 2	Mfundweni Reservoirs	1.1	80	uPVC	0.57	12

* Capacity based on velocity of 1.5m/s

Table 9.17 Pump Details: Ibisi Potable Water Pump Station

System	Pump Station Name	Pump Status		Pump Description	Supply From	Supply To	Static Head (m)	Duty Head (m)	Duty Capacity (Mℓ/day)	Approx. Age	Approx. Condition
		Duty	Stand by								
Ibisi	WTP PS	2	1	Grundfos CR 90 45Kw	Ibisi WTW	High Level Reservoirs	94	122.8	2.16	11	Good
Ibisi	Mfundweni PS	2	1	Indura BL19029 and Mono HD115M	High Level Reservoirs	Mfundweni Reservoir1 & 2	90	115*	0.675*	11	Fair

*calculated using reasonable assumptions

Table 9.18 Reservoir Details: Ibisi System

System	Reservoir Site	Reservoir Name	Capacity (Mℓ)	Reservoir Function	TWL (m ASL)	FL (m ASL)
Ibisi	High Level Res	Old Reservoir 1	0.15**	Bulk	718	716*
Ibisi	High Level Res	Old Reservoir 2	0.85**	Bulk	718	716*
Ibisi	High Level Res	New Reservoir	1.3	Bulk	719	716*
Ibisi	High Level Res	RC Tanks (4 x 70m ³)	0.28	Terminal	703.71	700*
Ibisi	Mfundweni	Mfundweni 1	0.25**	Terminal	810	808*
Ibisi	Mfundweni	Mfundweni 2	0.25**	Terminal	810	808*

*From measurements on Google Earth **From process controller

9.3.2 Status Quo and Limitations of the Upper uMzimkhulu System

Underberg

The exact usage of the Underberg System is unknown (as there is no metering at the plant) although staff on site indicates that the usage is approximately 1.5 Mℓ/day (June 2020). Although the raw water availability is adequate, the inflows and the outflows are not measured to determine the losses over the plant and in the infrastructure. The future demand can be accommodated within the capacity of the plant in the short to medium term provided proper maintenance and WC/WDM is in place. Should the town and surrounding area increase in size and demand, there is adequate space and raw water availability to expand the works and infrastructure to accommodate this. The raw water pumping main is the limiting factor in the system as it traverses very steep and rocky terrain and augmenting it would be costly.

Consultation with the operators prove that there are some leaks in the low cost housing areas in the town.

The WTP is in need of some repairs to bring it to full functionality. The backwash recovery system has been installed but has not been connected. The chemical storage facility should be upgraded and an emergency shower facility should be installed. The coagulant dosing pump should be replaced as there is only one pump operational and there is no backup at present. The plant also has no standby generator and a power cut results in no water being produced at the plant.

uMzimkhulu

The exact usage of the uMzimkhulu WTP is unknown at this stage as proper metering and records are not adequately kept. The capacity of the plant is adequate for the short-term supply and being a development node in the area, the possibility for expansion of the system is good. The system also supplies Clydesdale and if supply has to branch to other surrounding areas this will increase the demand on the plant. The plant has the space for expansion although the raw water supply infrastructure would need augmentation. The raw water source, being the uMzimkhulu River, has adequate yield to supply the demand in the area but monitoring of the abstraction should be undertaken. The limiting factor for uMzimkhulu System would be the raw water supply system and the pump station locality and configuration is of concern as it lies below ground and within close proximity to the river.

There has not been a report from the staff regarding the leaks in the reticulation or the bulk system although this can be assumed to be similar to other reticulated areas within the DM.

The plant has some maintenance issues which should be addressed. The filter pumps require maintenance and the stirrer for the flocculent mixing is not operational. No test laboratory is available within the plant. The staff are concerned with security at night since the security lighting is not

operational. The standby dosing pump should be replaced. There are no working meters within the WTP.

Upon consultation with the operators and the process controller, it was discovered that there is an off-channel storage dam being constructed to the north of the town. Raw water will be pumped from the site of the existing raw water pump station to this dam and water will be gravity fed to the WTP. A new abstraction pontoon has been installed and the project is underway. At the time of this report, no further information on this project was available.

Ibisi

The exact supply from the Ibisi WTP is unknown at this stage as there is no metering at the plant. There is also ambiguity regarding the size and capacity of the plant and it is assumed to be in the order of 2 Mℓ/day after consultation with the process controller and superintendent. The exact supply area of the plant is also unknown as there are no as built drawings available. The yield of the Ibisi River at the abstraction point should to be determined through a hydrological study. Further investigation from an infrastructure and process engineering should be conducted.

There is no standby power for the plant and during power outages there is no water produced at the plant. Power outages in the area are frequent and extend for long periods.

There are reports of the reticulation system having leaks but there is no way to quantify the losses due to the lack of metering. No further reports of infrastructure constraints are available and the Ibisi/Mfundweni System seems adequate to supply the medium to long term demand as the projected demand for 2050 is 1.65 Mℓ/day (UAP Phase 3).

9.4 Water Balance/Availability

According to DWS (2016) and the 2022/2023 abstraction records obtained from the Harry Gwala District Municipality, the water balances of the main water supply schemes are as follows:

- **Underberg Himeville Water Supply Scheme**
This scheme supplies the rural towns of Underberg and Himeville and is dependent on the uMzimkhulu River as its main source of water supply. There is sufficient water available based on the run-of-river abstraction for the Underberg-Himeville Water Supply Scheme to meet the current demands. The available water supply is approximately 1.76 Million m³ / annum (4.8 Mℓ/day) and is sufficient to meet the 2022/2023 demand of 0.75 Million m³ / annum (2.06 Mℓ/day).
- **uMzimkhulu Water Supply Scheme**
uMzimkhulu is a rural town where the high level of service provision is implemented. The available water for the scheme from the uMzimkhulu River, as well as groundwater, amounts to 4.0 million m³/annum (11 Mℓ/day) which was sufficient to meet the 2022/2023 water demands of 1.24 million m³/annum (3.38 Mℓ/day).

- **Ibisi Water Supply Scheme**
Ibisi is a rural town where a high level of service provision is implemented. The available water for the scheme from the Ibisi River as well as groundwater amounts to 0.33 million m³/annum (0.9 Mℓ/day) which was not sufficient to meet the 2015 water demands of 1.1 million m³/annum (3 Mℓ/day). The current water balances (requirements and available supply) for the Ibisi water supply scheme could not be obtained from the Harry Gwala District Municipality for the purposes of this year's infrastructure Mater Plan review.

9.5 Recommendations for the Upper uMzimkhulu System

9.5.1 System Components

A detailed investigation into the irrigation water use should be undertaken with particular emphasis on the upper uMzimkhulu catchment. This investigation should include an assessment of the future irrigation requirements, the identification of practical water conservation measures and an extent to which these can be implemented. Note must be made that the systems detailed in this section are not owned and operated by UUW and the access to information is of a very limited nature.

Underberg System

The recommendations for Underberg are as follows:

- An investigation should be conducted to determine and document the as-built infrastructure for the scheme to assist in the future development or expansion of the system.
- Detailed hydraulic investigations should be conducted on the system.
- A water resources availability (firm yield) analysis should be conducted at the abstraction point.
- A hydro-meteorological monitoring network must be established for water resources management and development.
- A meter audit should be done to determine the condition and possible installation of meters at key points.
- A standby generator should be included to keep the works operational during power outages.
- An upgrade of the chemical storage facility should be undertaken.
- Electricity to the backwash system should be connected.
- The coagulant dosing pump should be replaced.
- The streaming current detector should be replaced.
- Leaks in the low-cost housing area should be addressed.
- Access and parking at the raw water pump station should be developed to assist with maintenance operations.
- A maintenance plan and schedule should be developed and implemented.

uMzimkhulu System

The recommendations for uMzimkhulu System are as follows:

- An investigation should be conducted to determine and document the as-built infrastructure for the scheme to assist in the future development or expansion of the system.
- A water resources availability (firm yield) analysis should be undertaken at the abstraction point.
- A hydro-meteorological monitoring network must be established for water resources management and development.
- Detailed hydraulic investigations should be conducted on the system especially pertaining to the pumping system.
- A meter audit should be undertaken to determine the condition and possible installation of meters at key points.
- A laboratory should be implemented on site.
- The flocculent mixing stirrer and pump should be replaced.
- The standby dosing pump should be replaced.
- Security lighting should be upgraded.
- A maintenance plan and schedule should be implemented.

Ibisi System

The recommendations for Ibisi are as follows:

- An investigation should be conducted to determine and document the as-built infrastructure for the scheme to assist in the future development or expansion of the system.
- A water resources (firm yield) analysis should be undertaken at the abstraction point.
- A hydro-meteorological monitoring network must be established for water resources management and development.
- Detailed hydraulic investigations should be conducted on the system
- A meter audit should be undertaken to determine the condition and possible installation of meters at key points.
- The flocculation dosing line should be replaced.
- A standby generator to be installed on the site.
- On site facilities should be provided i.e toilets, lab testing facilities and an office.
- The plant should be properly fenced.
- Security lighting should be installed.
- A maintenance plan and schedule should be developed and implemented

9.5.2 Long Term Recommendation

The ultimate long term recommendation for the upper uMzimkhulu system would be the uMzimkhulu Bulk Water Supply System (see Chapter 8 – 8.5.2 (a) uMzimkhulu Bulk Water Supply Scheme). This regional scheme would be able to supply bulk potable water to the areas of Mzimkhulu and Ibisi but would not be able to supply Underberg due to geographical constraints. The Universal Access Plan Phase 3, however, indicates that the current size of the WTP at Underberg is sufficient to meet the 2050 demands for the area. The available yield in the uMzimkhulu River will be adequate to meet any growth within the area.

REFERENCES

uMngeni-uThukela Water. 2020. Universal Access Plan Phase 3 – Universal Access Plan Phase 3 – Progressive Development of A Regional Concept Secondary Bulk Water Master Plan For The Harry Gwala District Municipality. Prepared by Mariswe Consulting (Pty) Ltd in Association with JTN Consulting for uMngeni-uThukela Water. Contract No. 2018/164. uMngeni-uThukela Water: Pietermaritzburg.

Department of Water Affairs. 2010. *Water Supply and Drought Operating Rules for Stand-Alone Dams and Schemes Typical of Rural/Small Municipal Water Supply Schemes: Eastern Cluster Buffalo River Catchment (Newcastle, Glencoe, Dundee and Others)*. Prepared by BKS (Pty) Ltd. Department of Water Affairs: Pretoria.

DWS. 2016. *Water reconciliation strategy of the schemes in the uMzimkhulu River System in Harry Gwala District Municipality for the period 2015 to 2045*

DWA. 2011. *uMzimkhulu river catchment water resource study - Surface Water Resource Report*

DWS. 2018. *Reserve Determination of Water Resources for the Mvoti to uMzimkulu Catchments*. Government Gazette No. 1097. Department of Water and Sanitation: Pretoria, South Africa.

10. UPPER MZINTLAVA SYSTEM

10.1 Synopsis of the Upper Mzintlava System

The Greater Kokstad Local Municipality is located in the south-western corner of KwaZulu-Natal, with Lesotho bordering it in the north-west and the Eastern Cape, on the west and the south (**Figure 10.1**). The source of the Mzimvubu¹ River, one of the largest rivers in the Eastern Cape, is located in the Greater Kokstad Local Municipality. The municipality is located predominantly in the catchments of the Upper Mzimvubu River and the Upper Mzintlava River, one of the tributaries of the Mzimvubu River, with only a small area in the north-east in the vicinity of Kingscote occurring in the Upper uMzimkhulu Catchment (**Section 9**).

The Upper Mzintlava River supplies the village of Franklin and the town of Kokstad (**Figure 10.2** and **Figure 10.3**). Kokstad is the administrative seat of the Greater Kokstad Local Municipality and the service centre and commercial hub for the region which is predominantly commercial agriculture, commercial forestry and subsistence agriculture. The settlements of Swartberg, Makhoba, Willowdale, Pakkies, New Amalfi and Bonny Ridge are supplied by local stand-alone schemes.

uMngeni-uThukela Water currently does not own or operate infrastructure in the Upper Mzintlava region.

¹ "home of the hippopotamus" in isiXhosa (Department of Arts and Culture 2009: <http://www.salanguages.com/munnames.htm>).

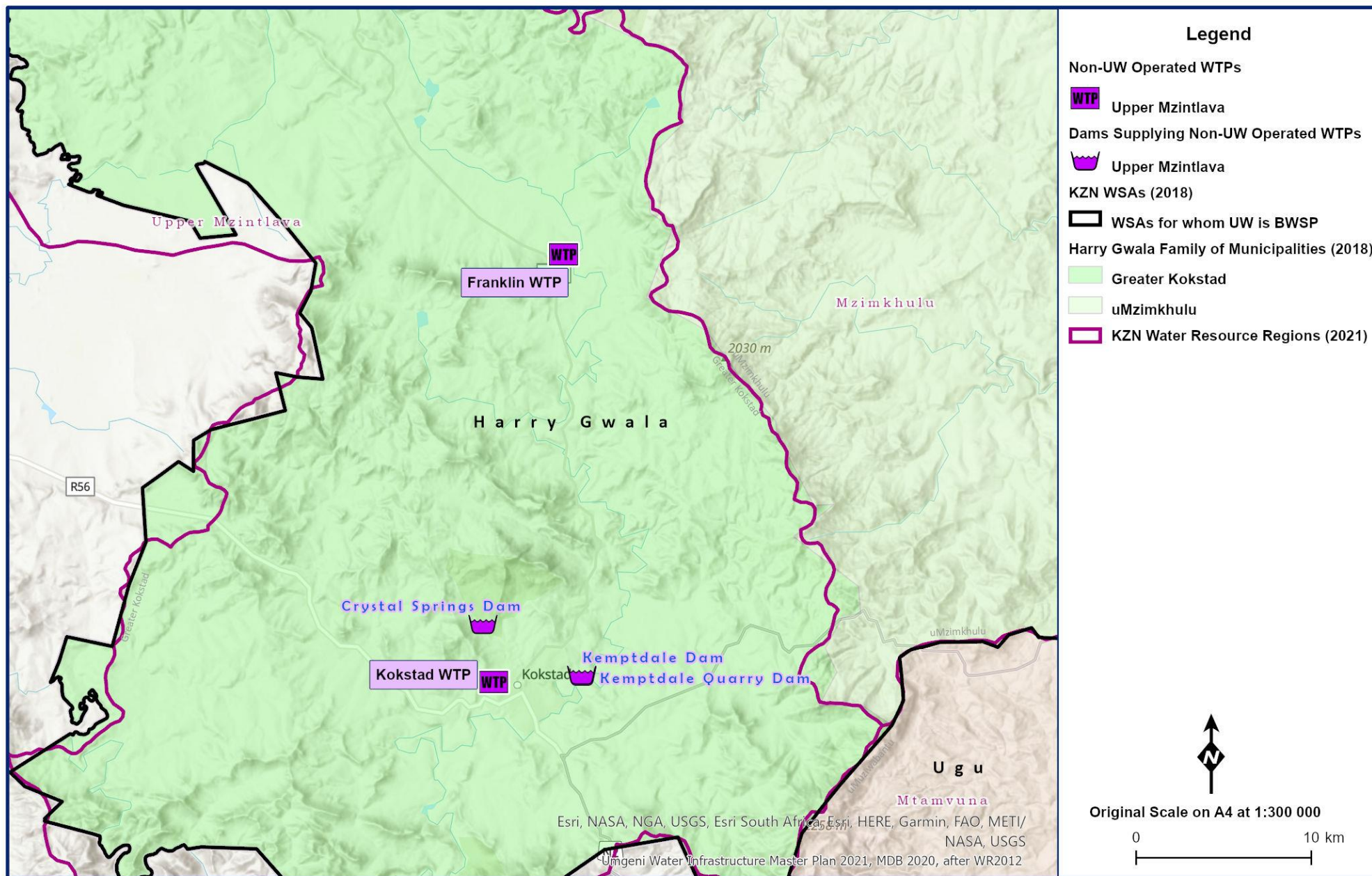

Figure 10.1 General layout of the Upper Mzintlava System.

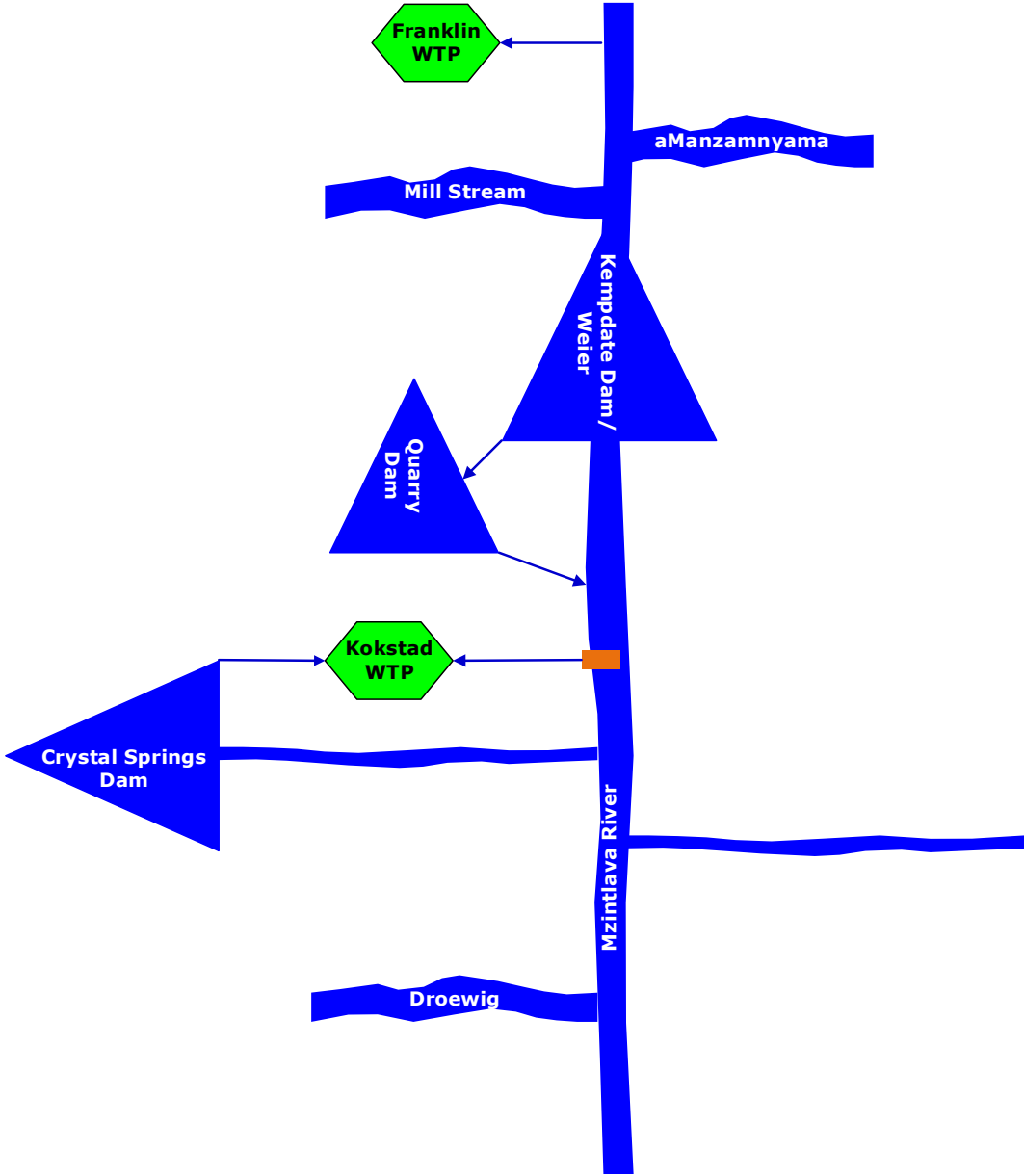
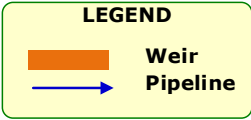

Figure 10.2 Schematic of the Upper Mzintlava River System.

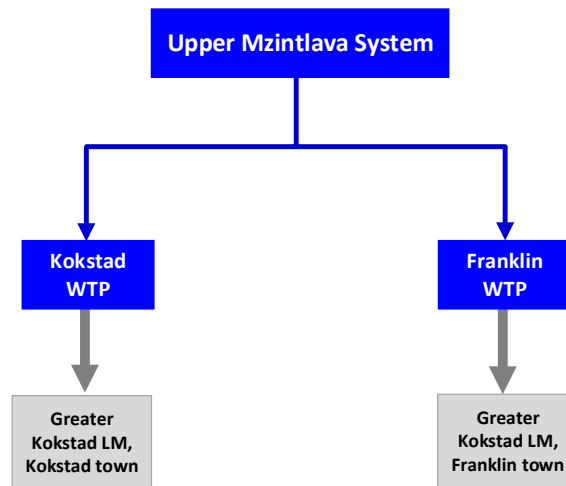

Figure 10.3 Network chart of the Upper Mzintlava System.

10.2 Water Resources of the Upper Mzintlava System

10.2.1 Description of the Upper Mzintlava System Water Resource Regions

(f) Upper Mzintlava Region

(iv) Overview

The Mzimvubu River headwaters are in the Maloti-Drakensberg watershed (DWS 2017: 2-1), on the Lesotho-KwaZulu-Natal (KZN) border (2929CC 1 : 50 000 Topographic Map 2013). The Mzimvubu River initially meanders in a southerly direction. After the confluence with the Krom River, which discharges into the Mzimvubu River from the east (3029AA 1 : 50 000 Topographic Map 2013), it flows in a south-westerly direction. It then becomes the KZN-Eastern Cape border at the confluence with the Mngeni River, which flows into it from the north (3029AA 1 : 50 000 Topographic Map 2013). The Mzimvubu River, continues meandering in a southerly direction as the KZN-Eastern Cape border. Approximately 850 m downstream of the confluence with the Riet River (approximately 1.8 km north-west of the New Almafi), which flows into it from the east, it stops demarcating the KZN-Eastern Cape border and begins flowing in a southerly direction through the Eastern Cape. Ultimately the river discharges into “the Indian Ocean through the impressive "Gates of St John" gorge, an estuary located at Port St. Johns” (Wikipedia 2020: website).

Whilst the upper reaches of the Mzintlava River are in the Greater Kokstad Local Municipality, the Mzimvubu-Mzintlava confluence is in the Eastern Cape. The headwaters of the Mzintlava River are in a wetland located at a place called Flintwick Grange, approximately 8 km south-west of the KwaTshweleza Hill (Spot Height 1923) in the Ntsikeni Wildlife Reserve (3029AB 1 : 50 000 Topographic Map 2013) and approximately 8.4 km north-east of the Swartberg village (3029AB 1 : 50 000 Topographic Map 2013). The Mzintlava meanders in a south-easterly direction before flowing in a southerly direction at a farm dam located approximately 2.8 km north-west of the Llewellyn Rail Station (3029AD 1 : 50 000 Topographic Map 2013) into the Franklin wetland. The Mzintlanga-Mzintlava confluence is located 3.6 km north of Franklin. The Mzintlava then continues meandering in a southerly direction, past the Spitskop Hill (Trig Beacon 302 at an elevation of 1881.3 mASL;

3029AD 1 : 50 000 Topographic Map 2013) and Ben Nevis Hill (Trig Beacon 286 at an elevation of 2020.6 mASL; 3029BC 1 : 50 000 Topographic Map 2013) in the east. It flows down the Bailden Waterfalls at the Bailden Rail Station before flowing past Mount Currie (Trig Beacon 45 at an elevation of 2224.1 mASL) and the Mount Currie Nature Reserve. It then enters the Amanzamnyama wetland approximately 1 km east of the Karg's Post Railway Station. The headwaters of the Amanzamnyama River are on the Ngele Mountain on the Greater Kokstad-uMuziwabantu border and the river flows in north-westerly direction past Willowdale and into the Mzintlava River.

Approximately 380 m downstream of the Amanzamnyama-Mzintlava confluence, the Mill Stream flows into the Mzintlava from the west. The Crystal Springs Dam, in the Mount Currie Nature Reserve is approximately 7.4 km west of the Mill Stream-Mzintlava confluence as the crow flies (3029CB 1 : 50 000 Topographic Map 2013). The Mzintlava continues flowing in a southerly direction, turning west into the Kemptdale Dam (the dam wall is approximately 780 m upstream of the south-easterly corner of Shayamoya). Immediately downstream of the Kemptdale Dam Wall, on the northern bank of the Mzintlava River is the disused Kemptdale Quarry. The Mzintlava flows past the Kemptdale Quarry, through a weir (located approximately 165 m south of Shayamoya) and continues in a south-westerly direction past Shayamoya, Bhongweni and around Horseshoe, where the unnamed river, on which the Crystal Springs Dam is located, flows into it. The Mzintlava meanders along the southern edge of Kokstad, with the Droewig River flowing into the Mzintlava approximately 3 km south-east of the Kokstad Prison as the crow flies. The Mzintlava then flows south, into the Eastern Cape at the Greater Kokstad-Umzimvubu Local Municipal boundary, approximately 6 km north-east of the Lutambeko Hill (Trig Beacon 172 at an elevation of 1695.6 mASL).

(v) Surface Water

For the purposes of this report, the Upper Mzintlava Region is composed of a portion of the Upper Mzimvubu region (quaternary catchments T31A; T31B; T31C; T31D and T31J) and the Upper Mzintlava region (quaternary catchments T32A; T32B; T32C and T32D). The predominant land cover is grassland at approximately 60.6% and cultivated land at approximately 24.3% (**Figure 10.4**). The hydrological characteristics are summarised in **Table 10.1**.

The land use of the upper Mzintlava Region includes moderate to intense agriculture (dryland cultivation and irrigation), with numerous minor instream and off-channel farm dams that have a combined capacity of 14.85 million m³ (DWAf, 2009). A cumulative area of 41.7 km², in the Upper Mzintlava region is covered by invasive alien vegetation that causes a reduction in streamflow (DWS, 2017). Return flows from the Kokstad Waste Water Treatment Works (WWTW) enter the river system in quaternary T32D. The lower portion of the Mzintlava catchment (T32E – T32H) is characterised by rural villages and dryland subsistence farming. Erosion and sedimentation are prominent in this part of the catchment as a result of poor land use practices in the zone.

The following towns/villages are located in the zone:

- Franklin, T32A
- Kokstad, T32C/D
- Flagstaff, T32H
- Mount Ayliff and various rural villages, T32E-G

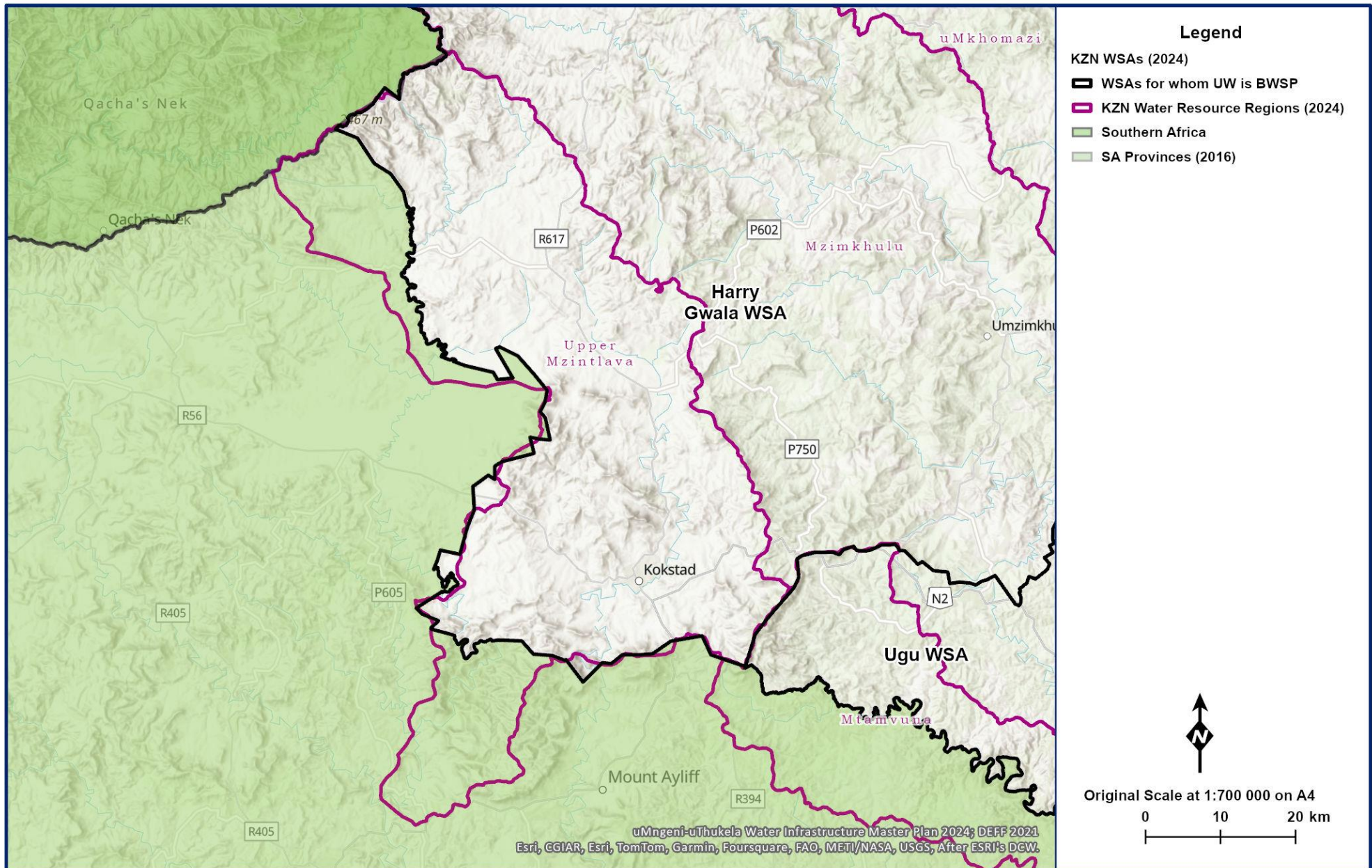

Figure 10.4 Upper Mzintlava land cover (DEFF 2020; MDB 2020; Umgeni Water 2022).

Table 10.1 Upper Mzimvubu and Upper Mzintlava hydrological characteristics (WR2012: Mzimvubu to Keiskamma Quat Info WMA 12Jul2015 Spreadsheet).

Region	River (Catchment)	Area (km ²)	Annual Average			
			Evaporation (mm)	Rainfall (mm)	Natural Runoff (million m ³ /annum)	Natural Runoff (mm)
Upper Mzimvubu	Mzimvubu Headwaters (T31A)	222	1350	907	31.98	144.1
	Krom River (T31B)	284	1350	833	30.96	109.0
	Mngeni (T31C)	291	1350	830	31.17	107.1
	Riet River (T31D)	353	1350	736	24.77	70.2
	Ngwekazana (T31J)	507	1300	807	52.27	103.1
Upper Mzintlava	Mzintlava Headwaters (T32A)	348	1300	804	35.02	100.6
	(T32B)	307	1250	814	34.83	113.5
	Amanzamnyama (T32C)	373	1200	781	40.63	108.9
	Droewig River (T32D)	351	1250	789	33.04	94.1
	Total	3036				

(vi) Groundwater

The Upper Mzintlava Region is located in the Transkeian Coastal Foreland and Middleveld Hydrogeological Region which “approximates the area of the shales and mudstones of the Ecca and Beaufort Groups” (DWS 2017: 17-4). The former DWAF states that “the aquifer types occurring in this region are mapped as low to medium potential and the geology consists of mostly arenaceous rocks” (DWAF 2008: 20). The stratigraphy within the Upper Mzintlava catchment is the Adelaide Subgroup and within the Upper Mzimvubu catchment the Tarkastad Subgroup (DWS 2017: 17-5).

• Hydrogeological Units

The geology occurring in quaternary catchments T31A – T31D is Tarkastad and dolerite and in quaternary catchments T32A – T32D and T31J Adelaide and dolerite. Valley bottom wetlands and seeps are present with base flow interflow driven with a component from the regional aquifer (DWS 2017: 17-14).

• Geohydrology

The aquifer types present in this region are intergranular and fractured (weathered and fractured) (DWS 2017: 17-6). DWS identifies that “secondary fractured and weathered aquifers are found throughout the region” and that “weathering gives rise to low to moderately-yielding aquifers where groundwater is stored in the interstices in the weather saturated zone and in joints and fractures of competent rocks” (2017: 17-7).

EKZNW states that the “Mount Currie Nature Reserve contains abundant shallow groundwater with Crystal Spring feeding in the Crystal Springs Dam” (2013: 15). Springs therefore play an important role in water supply in the region. DWS explains as follows:

“Springs play a vital role in the groundwater resources of the region. Springs also provide important habitat for wildlife and vegetation, and can result in wetlands.

Springs can occur at the margins of dolerite ring structures, emerging at different places along the dolerite rings where the side slopes consisting of dolerite prevent deeper infiltration. These springs can form the origin of first order streams, where they are associated with wetlands. These springs usually occur on the lower slopes and the inner side of the ring, due to water flowing through shallow dipping fractures parallel to the walls of the intrusion. This type of spring implies a perched water table (interflow) that also feed the wetlands and marshy areas in the fractured dolerite.

Some springs occur below the outer sill, in the sedimentary rocks. They result from water seeping through the vertical cooling cracks of the sill, through the sediment. They emerge at a more impermeable sedimentary layer (mudstone).

Dolerite sills also generate discharge as high-lying springs since the recharge areas at the top of a sill, or trapped between the top of the sill and the overlying sediment, can form perched aquifers. This results in interflow at high elevation and forms elevated springs or seeps feeding the drainage system.

The transition between sandstone-rich formations and low permeability mudstone-rich layers, like the contact between the Molteno and Burgersdorp Formations, can also result in springs, where groundwater percolating through sandstone emerges above low permeability mudstone, resulting in interflow if of sufficient volume.

Some springs are also located alongside dykes, indicating compartmentalisation.

The distribution of springs, when analysed and compared with the presence of dolerite sills and rings, indicated that the dolerite sills in the area belong to the tectonic domain defined between 500 and 900 mamsl. This is where flat sills and large shallow ring-type structures start developing instead of dykes.”

(DWS 2017: 17-8 – 17-9)

- **Groundwater Potential**

The groundwater potential for the Upper Mzintlava Region is illustrated in **Figure 10.5**. It is shown in **Figure 10.5** that the Crystal Springs Dam is situated in an area where the groundwater yield is greater than 3ℓ/s.

(vii) **Water Quality**

- **Surface Water**

Cattle farming is prevalent from Matatiele down to the Kokstad area in T32. There are productive abattoirs, intensive commercial maize and dairy production areas located around Kokstad. A large variety of other agricultural products are produced varying from vegetables to mutton. Several commercial farmers have been exploring ways to improve grazing productivity through changing fire and seasonal grazing regimes, and have increased carrying capacity and stocking rates. The area north of Mount Ayliff has irrigation and dryland farming along the Mzintlava River, with an industrial hub at Kokstad, while the mountainous area to the south of Mount Ayliff up to the confluence of the Mzintlava and Mzimvubu rivers has irrigation and dryland farming only. Water quality impacts in this catchment are related to elevated nutrients and turbidities, and urban pollution around Kokstad.

- **Groundwater**

The geology of this region is described as Transkei coastal foreland and middleveld with valley bottom wetlands and seeps. The baseflow is interflow driven with a component from the regional aquifer (DWS, 2011). The impacts of land use practices in this catchment does not only affect surface water resources, but extends to water quality of the groundwater resources.

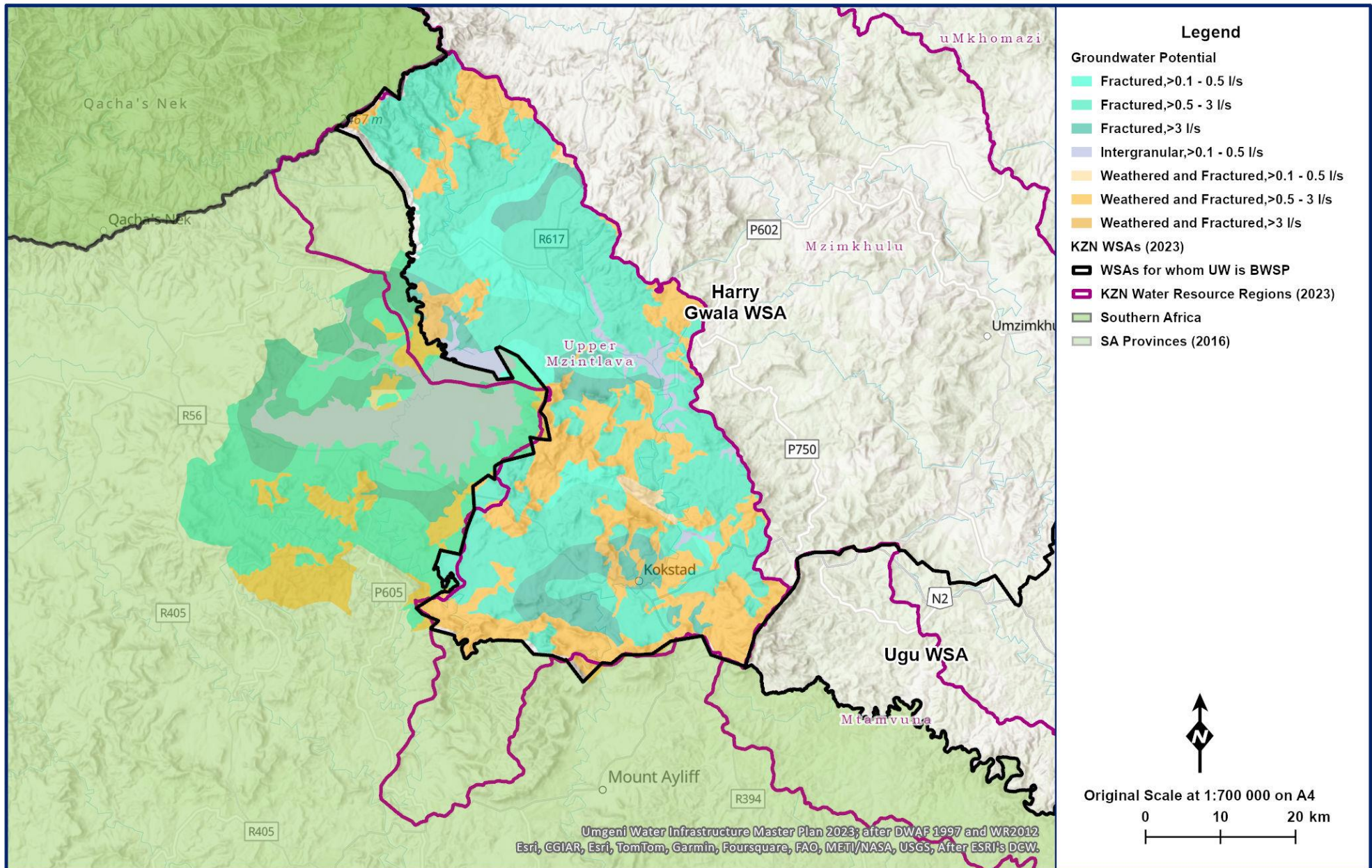

Figure 10.5 Upper Mzintlava groundwater potential (MDB 2020; Umgeni Water 2022; after DWAF 1997 and WR2012).

10.2.2 Reserve

DWS prioritised the Mzimvubu catchment in 2017 for implementation of the water resource classification system. This system helps in determining appropriate water resource classes and resource quality objectives to facilitate the sustainable use of water resources without impacting negatively on their ecological integrity. These resource classes guide the management of the catchment towards meeting the objectives of maintaining, and if possible, improving the present state of the Mzimvubu River and its four main tributaries, namely the Tsitsa, Thina, Kinira and Mzintlava.

The determination of the Present Ecological State (PES) is key in representing the ecological status quo of the rivers, and it is expressed in terms of various components, i.e. drivers (physico-chemical variables, geomorphology, hydrology) and biological responses (fish, riparian vegetation and aquatic macroinvertebrates), as well as in terms of an integrated state, the EcoStatus. Different processes are followed for each component to assign a category from A to F (where A is natural, and F is critically modified). Ecological evaluation against the expected reference conditions, followed by integration of the categories of each component, provides a description of the Ecological Status or EcoStatus of a river.

The Upper Mzintlava River area consists primarily of the quaternary catchments T32A, T32B and T32C to the north of and including the town of Kokstad. The predominant present ecological state of this area is moderately modified from natural conditions (Class C) although the lower reaches around Kokstad are largely modified (category D) (DWS, 2017). The Environmental Water Requirements (EWR) at various sites in the Upper Mzintlava and upper Mzimkhulu region are outlined in the river desktop EWR and modelling report (DWS, 2017).

10.2.3 Existing Water Resource Infrastructure

(a) Upper Mzintlava Region

Kokstad receives its water from two main sources, Crystal Springs Dam and Kemptdale Dam.

The water resource infrastructure supplying Kokstad is shown in **Figure 10.6** and comprises the following:

- **Crystal Springs Dam (Figure 10.7 and Table 10.2):** The town's principle source of raw water is the 2.14 million m³ Crystal Springs Dam located 3.6 km up the valley from the water treatment plant. This dam has a relatively small catchment area (15 km²), with a natural mean annual runoff of 0.81 million m³ (DWS, 2023), but is fed by several strong springs which deliver a minimum of about 2.5 Mℓ/day, even at the height of severe droughts. Together with the springs, the dam has a firm yield of about 4.5 Mℓ/d.

During average and above-average rainfall years, the dam yield comfortably exceeds Kokstad's projected water demands and, being a gravity supply to the WTP, it should be used to provide the full demand at the WTP when full or nearly full.

The dam is linked to the WTP by means of a 3.6 km long FC pipelines and a uPVC pipeline.

- **Mzintlava River:** The existing infrastructure making use of the Mzintlava River comprises the following:

Kemptondale Dam (Figure 10.8 and Table 10.4): 5.8m high rollcrete dam wall founded on competent dolerite bedrock. It has an estimated storage capacity of 400 000 m³. The catchment area is considerably larger than Crystal Springs Dam (860 km² vs 15 km²) which means the dam, when empty, takes only a single significant rainfall (or snowfall) event anywhere in the catchment to fill it again. The Kemptondale Dam catchment has a natural mean annual runoff of 89 million m³ (DWS, 2023). This dam is used to release water downstream to the abstraction weir and pump station over the mid-winter months when extensive upstream irrigation tends to reduce the river flow to a trickle. The dam was completed in Sept 2004. The catchment largely comprises well managed agricultural land and therefore has a far lower silt load than most KZN rivers of this size. There are two augmentation schemes that have been recommended for this system, i.e., raise the dam wall to a total height of 8m, thereby increasing the storage capacity to about 750 000 m³ and double the capacity of the pumping main from Kemptondale Dam weir to the WTP (15 Mℓ/day to 20 Mℓ/day).

Kemptondale Quarry: This is a disused dolerite stone quarry 25m deep alongside the river immediately downstream of the Kemptondale Dam. It provides an additional 250 000 m³ of emergency storage. It is filled under gravity by opening a valve on a pipeline from the dam and is emptied back into the river by means of two submersible pumps mounted on a raft moored over the deepest point of the quarry (pumps can deliver between 5 Mℓ /day when the quarry is full to 2 Mℓ/day when nearly empty).

Abstraction Weir, Pump Station and Pipeline: A 1.5m high mass concrete weir diverts river water to the pump station sump on the riverbank. The pump station has been equipped with two 130 kW vertical turbine raw water pumps (1 Duty, 1 Standby). The pump motors and electrical control panel are above the Mzintlava River's 1:50 year flood line. One pump delivers 5 Mℓ/d. If necessary, both pumps can be operated simultaneously to yield about 7.5 Mℓ/day (24h pumping). The weir was deliberately sited upstream of the developed areas so that the water quality would not be affected by runoff pollution or sewage reticulation spills. The delivery pipeline to the waterworks is 300mm in size and 5.0 km long. The pumping scheme was commissioned in May 2004. With the large catchment area, Kemptondale Dam, the quarry and the river pump station enjoys a high level of assurance of supply at its current capacity and if properly managed (i.e. if releases from the dam are carefully controlled over the mid-winter months). It should be noted that Kokstad experiences frequent power failures (over and above scheduled load shedding) which affects the delivery of water to the waterworks, and the treatment thereof.

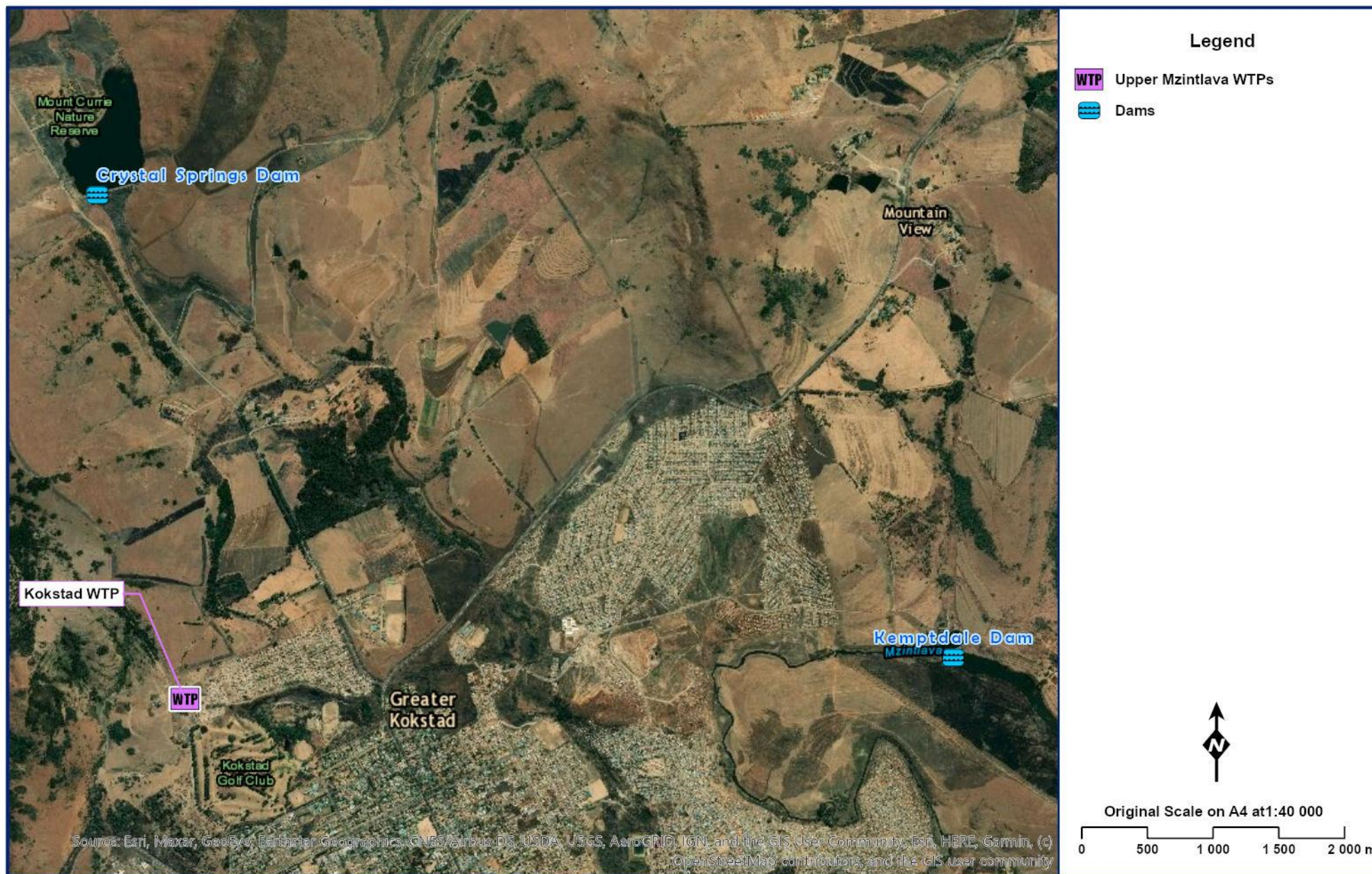

Figure 10.6 General layout of water resource infrastructure supplying Kokstad.



Figure 10.7 Crystal Springs Dam (Nightjar Travel Guide South Africa 2017: website).

Table 10.2 Crystal Springs Dam (DWS 2018: Hydrographic Surveys Dams Database, DWS 2019: List of Registered Dams Database, WR2012, DWS 2023: Drought Operating Rules for the Kokstad Water Supply System).

Catchment Details	
Incremental Catchment Area:	15 km ² ^a
Total Catchment Area:	15 km ² ^a
Mean Annual Precipitation:	781 mm ^b
Natural Mean Annual Runoff:	0.81 million m ³ ^g
Annual Evaporation:	1200 mm ^b
Dam Characteristics	
Gauge Plate Zero:	1406.2 mASL ^d
Full Supply Level:	1427.2 mASL ^d
Spillway Height:	21 m ^e
Raised Dam Net Full Supply Capacity:	2.14 million m ³ ^e
Dead Storage:	N/A
Raised Dam Total Capacity:	2.14 million m ³ ^e
Surface Area of Dam at Full Supply Level:	0.29 km ² ^e
Original Measured Dam Capacity (Dam Raised – 1996)	1.306 million m ³ (1967) ^f
Dam Type:	Earth-fill ^e
Crest Length:	Crest Length: 374m ^e Spillway Section: 60 m ^d Non-Spillway Section: 314 m ^d
Type of Spillway:	Ogee Spillway ^e
Capacity of Spillway:	650 m ³ /s ^d
Date of Completion:	1967 ^e
Date of Area Capacity Survey:	1996 ^f
Date of next Area Capacity Survey:	2031 ^f

^a Calculate using Spatial Analyst tool on ArcGIS.

^b WR2012 Database of Quaternary Catchment Information.

^c Calculated using the identify tool on ArcGIS and converted to million m³.

^d Crystal Springs Dam Safety Inspection 2003

^e DWS List of Registered Dams Database (April 2019).

^f DWS Hydrographic Surveys Dams Database (2018).

^g DWS (2023)

The Greater Kokstad water supply rule developed by DWS has an objective to make the best use of multiple resources to maximise yield and minimise cost (DWS, 2016). The yield of the system is dependent on the operating rule. Different scenarios of maximising the yield from the resources available in the Kokstad System (DWS, 2023) are explained below:

- Scenario 1 – Stand-alone dams only:
- Scenario 1.1 – Crystal Springs Dam used as the sole source.
- Scenario 1.2 – Kemptdale Dam used as the sole source.
- Scenario 1.3 – Kemptdale Dam with the quarry as the sole source.

- Scenario 2 – Crystal Springs Dam utilised first: Utilising the spills from both dams, Crystal Springs and Kemptdale dam. Firstly, supplying water from the cheaper resource, Crystal Springs Dam, to the WTP and augmenting the difference with water from Kemptdale Dam. This scenario has an infrastructure capacity constraint of 0.085 m³/s from Kemptdale Dam, via Mzintlava pump station to the WTP. A scenario with EWR (2.1) and without EWR (2.2) releases was considered.
- Scenario 3 – Maximum yield for current capacity constraint: Water is first sourced from the Kemptdale Dam and released into the Mzintlava River, where it is pumped at a maximum flow of 0.085 m³/s to the TWP. The outstanding demand is supplemented from Crystal Springs Dam.

The storage capacity of the quarry was included in the yield analysis for both scenarios. The results of the yields of these scenarios are shown in **Table 10.3** and the characteristics of the dam are shown in **Table 10.4**.

Table 10.3 Yields of dams in the Mzintlava (Million m³/annum) (DWS 2023)

Scenario	Historic Firm Yield	Stochastic yield		
		1:100	1:50	1:20
1.1	0.74	2.07	2.10	2.20
1.2	0.76	1.05	1.17	1.3
1.3	1.63	1.45	1.60	1.80
2.1	1.88	N/A	N/A	N/A
2.2	2.65	3.80	3.90	4.10
3	4.80	4.70	4.80	4.90

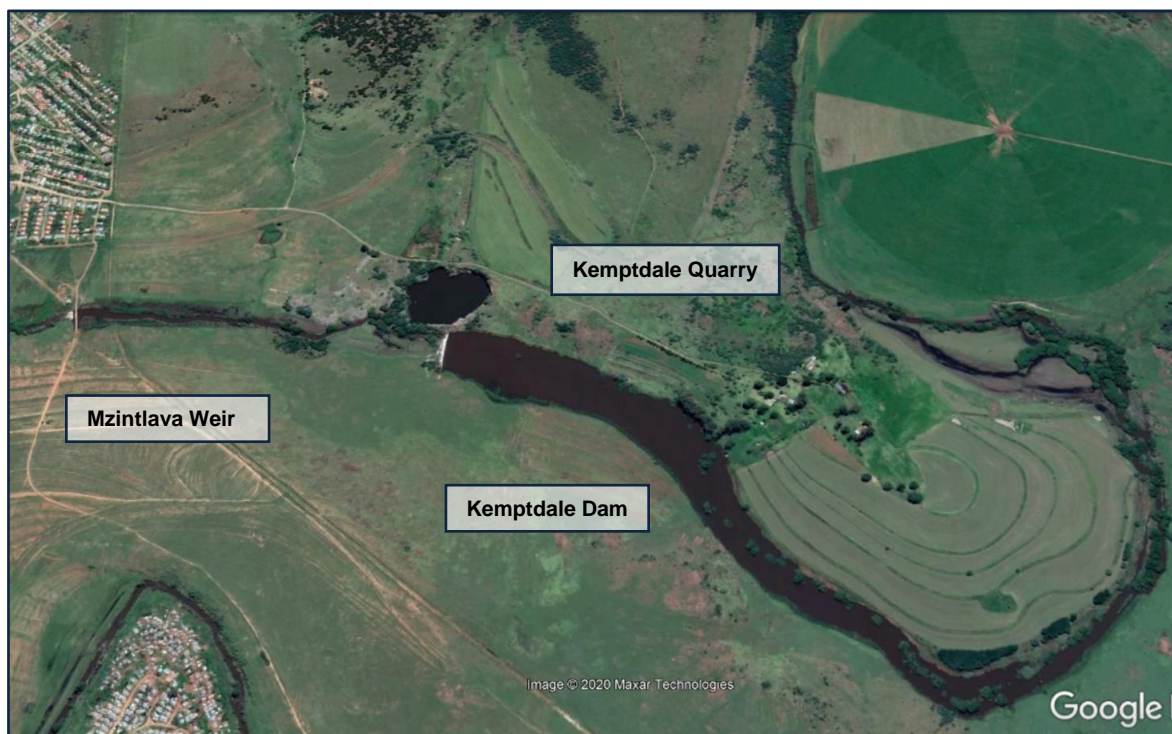

Figure 10.8 Kemptdale Dam, Kemptdale Quarry and Mzintlava Weir (Google Earth 2020: website).

Table 10.4 Kemptdale Dam (DWS 2018: Hydrographic Surveys Dams Database, DWS 2019: List of Registered Dams Database, WR2012, DWS 2023: Drought Operating Rules for the Kokstad Water Supply System).

Catchment Details	
Incremental Catchment Area:	861.7 km ² §
Total Catchment Area:	861.7 km ² §
Mean Annual Precipitation:	781 mm ^b
Natural Mean Annual Runoff:	89.0 million m ³ §
Annual Evaporation:	1200 mm ^b
Dam Characteristics	
Gauge Plate Zero:	1273 mASL ^d
Full Supply Level:	1279 mASL ^d
Spillway Height:	6 m ^e
Net Full Supply Capacity:	0.40 million m ³ ^e
Dead Storage:	N/A
Total Capacity:	0.40 million m ³ ^e
Surface Area of Dam at Full Supply Level:	0.26 km ²
Original Measured Dam Capacity	0.40 million m ³ ^e
Dam Type:	Concrete
Crest Length:	Crest Length: 150 m ^f Spillway Section: 52 m ^f Non-Spillway Section: 98 m ^f
Type of Spillway:	N/A
Capacity of Spillway:	Overflow Spillway across the entire width of the river
Date of Completion:	N/A
Date of Area Capacity Survey:	N/A
Date of next Area Capacity Survey:	N/A

^a Calculate using Spatial Analyst tool on ArcGIS.

^b WR2012 Database of Quaternary Catchment Information.

^c Calculated using the identify tool on ArcGIS and converted to million m³.

^d 0.5 m contours from DEM.

^e DWS List of Registered Dams Database (April 2019).

^f Measured on Google Earth

[§] DWS(2023)

10.2.4 Operating Rules

The highest yield is obtained when the system is operated optimally by supplying water from the Kemptdale Dam first and utilising Crystal Springs Dam to supplement the water requirement deficit (DWS, 2023)

The system is currently operated by considering the Crystal Springs Dam as the first source of raw water supply and Mzintlava River, via releases from Kemptdale Dam as the secondary. Water is first released from the Crystal Springs Dam and then after from Kemptdale Dam to the abstraction weir

where it is pumped to the Kokstad WTP. This is the most economical option preferred by the municipality since water from Crystal Springs Dam is supplied under gravity. The WTP was upgraded in the last few years from 13 Mℓ/day to 18 Mℓ/day with additional filters. The release is usually done in winter because of the extensive irrigation taking place upstream of Kokstad and which reduces the flow of the Mzintlava River. Restrictions are applied when the cumulative storage level of the dams is below 30% of the full supply capacity, reducing the supply to 3.6 million m³/annum when the dams are empty.

The combined Kemptdale and Crystal Springs Dam drought rule curve, **Figure 10.9**, reflects the annual operating rule, assuming that the dam is operated optimally by using Kemptdale Dam as the primary resource. As the total system (Crystal Springs & Kemptdale Dams) draws down, the allocated volume reduces.

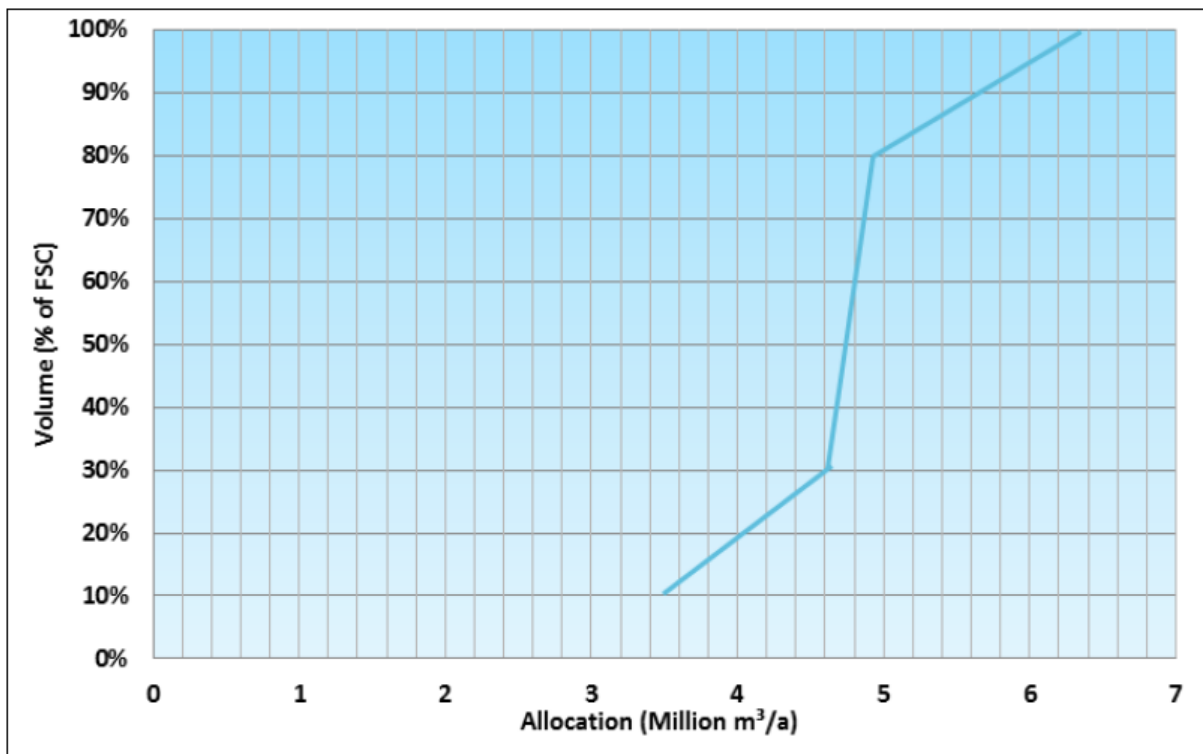

Figure 10.9 Kokstad System annual operating rule curve (DWS, 2016).

10.3 Supply Systems

10.3.1 Description of the Upper Mzintlava System

There is one primary bulk water supply scheme (BWSS) within the Mzintlava System:

- Kokstad BWSS – Kokstad Water Treatment Plant (WTP)

The other smaller WSS (water supply scheme) within the Mzintlava System:

- Franklin BWSS – Franklin WTP

For the purposes of this report, only WTP's of 2 Mℓ/day or greater were included as this constitutes a bulk system.

Brief description (locality and supply area) of the primary bulk WTP within the Mzintlava System:

- **Kokstad WTP:** The Kokstad WTP is located within the town of Kokstad, north of the golf course. It is located 3.5 km from the banks of the Mzintlava River and falls within the Greater Kokstad Local Municipality boundary. It is owned and operated by Harry Gwala District Municipality and supplies the entire town of Kokstad, industrial area, prison and suburbs, Bhongweni and Shayamoya.

More detailed information on the treatment plant and system follow in the next section.

(a) Kokstad Water Treatment Plant and Supply System

The primary sources of raw water for the Kokstad WTP (**Table 10.5**) are the Crystal Springs Dam and the Mzintlava River. The river can drop to very low levels during the Winter months, making it impossible to abstract water from this source. An off channel storage dam (Quarry Dam) utilises water from the Kemptondale Dam/Weir to store water for times of low flow. Water can be pumped back into the river upstream of the abstraction weir.

The Crystal Springs Dam relies heavily on supply from springs in the area and is water table dependant. During the winter months the flow from the springs is reduced and this is even more prevalent during a drought period as experienced in 2015.

The Kokstad Water Treatment Plant has been upgraded from 13Mℓ/day to 18Mℓ/day with the construction of an additional filter gallery. The plants historical output was approximately 15Mℓ/day and more recently this has been reduced to approximately 12.1 Mℓ/day, due to raw water supply issues. A site assessment was carried out by uMngeni-uThukela Water in 2015 and a report was compiled on the status of the treatment plant.

Table 10.5 Characteristics of the Kokstad WTP

WTP Name:	Kokstad WTP
System:	Mzimvubu River System / Mzintlava River Catchment
Maximum Design Capacity:	18 Mℓ/day
Current Utilisation:	12.1 Mℓ/day (as at July 2023, HGDM)
Raw Water Storage Capacity:	Crystal Springs Dam – DWS Dam, 2.1 million kℓ
Raw Water Supply Capacity:	The Crystal Springs Dam has a sustainable yield of 5.8 Mℓ/day but the infrastructure can provide 18 Mℓ/day. The raw water abstraction on the Mzintlava river can deliver 7.5 Mℓ/day.
Pre-Oxidation Type:	None
Primary Water Pre-Treatment Chemical:	Lime and polymeric coagulant (Wetfloc 7550L)
Total Coagulant Dosing Capacity:	15.2 ℓ/h
Rapid Mixing Method:	Mixing via a weir
Clarifier Type:	Pulsator type clarifiers (not operational)
Number of Clarifiers:	4
Total Area of all Clarifiers:	313.6 m ²
Total Capacity of Clarifiers:	22.6 Mℓ/d
Filter Type:	Rapid gravity sand filters
Number of Filters:	9 (3 old filters and 6 new filters)
Filter Floor Type	False floor
Total Filtration Area of all Filters	164.4 m ²
Total Filtration Design Capacity of all Filters:	23.6 Mℓ/d
Average Recovery Backwash water volume:	{Flow meter was not operational at the time and no method of measuring the lagoon level}*
Total Capacity of Sludge Dams:	{Did not get info}*
Capacity of Used Wash Water System:	{Did not get info}*
Primary Post Disinfection Type:	Chlorination (chlorine gas)
Disinfection Dosing Capacity:	0.7 kg/h
Disinfectant Storage Capacity:	14 (stored) + 1 (online) 70kg cylinders
Total Treated Water Storage Capacity:	14.8 Mℓ

* Plant Superintendent consulted and cannot provide this information

Raw water infrastructure for the two sources of the Kokstad WTP are summarised in **Section 10.2.3** and in **Table 10.6** and **Table 10.7**.

Table 10.6 Pump Station Details: Mzintlava River (weir), Raw Water

System	Pump Station Name	Pump Status		Pump Description	Supply From	Supply To	Static Head (m)	Duty Head (m)	Duty Capacity (Mℓ/day)	Approx. Age	Approx. Condition
		Duty	Standby								
Kokstad	Mzintlava River Pump Station	1	1	Vertical Turbine (132 kW) KSB 125/5	Mzintlava Weir	Kokstad WTP	119	142	4.32	39	Fair (Good)

Table 10.7 Pipeline Details: Kokstad System, Raw Water Supply Pipelines

System	Pipeline Name	From	To	Length (km)	Nominal Diameter (mm)	Material	Capacity * (Mℓ/day)	Age (years)
Mzintlava	Mzintlava Raw Water	Mzintlava Weir	Kokstad WTP	5 (approx.)	350	FC & Klambon	16.63	14*
Crystal Springs	Crystal Springs Raw Water	Crystal Springs Dam	Kokstad WTP	3.6 3.6	300 350	FC uPVC	9.16 12.47	48 34

**Info from Plant Superintendent*

Potable water supply systems downstream of the Kokstad WTP are presented below and in **Table 10.8**. Kokstad WTP supply's four reservoirs that are situated on-site. From these reservoirs the different areas are supplied as detailed below:

- Galaxy Tank (Extension7):** The 300 Kℓ Galaxy tank is supplied from the clear water sump in the filter building and potable water is pumped to the tank via a 75mm diameter uPVC pipe. This tank is one of the two supplies to Extension 7 to the north east of the town. Supply from the Galaxy Tank is via a 90 mm uPVC pipeline that changes to a 75 mm diameter uPVC pipeline at the fence of the WTP. This tank supplies the high lying areas within Extension 7. The low lying areas within Extension 7 are supplied by a 150 mm FC pipe from the clear water sump next to the new filter building.
- Main Reservoir (CBD Grenswag Reservoir, Golf Course Reservoir and Bhongweni Reservoir):** The Main Reservoir system, a 4.5 Mℓ reinforced concrete reservoir, is supplied by a 450 mm diameter FC pipeline from the clear water sumps. Potable water is supplied to Grenswag and Bhongweni reservoirs via a 450mm diameter FC pipe. The Bhongweni Reservoir site has an elevated steel water tank (50 kℓ) to supply the immediate areas. These reservoirs are terminal reservoirs that supply the CBD and the Bhongweni settlement. The main reservoir also has a 300 mm diameter FC offtake to the Golf Course Reservoir which serves the town. There is a cross connection between the main Reservoir and the Shayamoya Reservoir that is used if necessary.

- **Prison Reservoir:** The Prison Reservoir is supplied via a 200 mm diameter FC pipeline that is inter-connected with the 450 mm diameter FC supply from the plant to the Main Reservoir. This is a 5 Mℓ reinforced concrete reservoir and its sole supply is the C Max and medium security prison facilities situated in the south-east sector of the town.
- **Shayamoya Reservoir (Shayamoya High and Low Level Reservoirs):** The Shayamoya Reservoir in the WTP is supplied under gravity via a 450mm GRP pipe from the clear water sump in the new filter building. The reservoir is a 5 Mℓ reinforced concrete reservoir and has a cross connection with the Main Reservoir via a 450mm diameter GRP pipeline with isolation valves in place. The Shayamoya Reservoir supplies the Shayamoya Low Level Reservoir via a booster pump station located within the WTP. The supply line to Shayamoya Low Level Reservoir is a 200mm uPVC pipeline. Shayamoya Low Level Reservoir has another booster pump station located within the site and water is pumped via a 160mm diameter uPVC pipeline to Shayamoya High Level Reservoir and the water tower (22 kℓ) on site that provides water to the immediate vicinity. Both Reservoirs supply the community of Shayamoya exclusively.

The advanced age of the pipelines (see **Table 10.8**) would result in most requiring refurbishment or quite possibly replacement. Pump and reservoir details are presented in **Table 10.9** and **Table 10.10** with a schematic of the system presented in **Figure 10.10**

Table 10.8 Pipeline Details: Kokstad Potable Supply Pipelines

System	Pipeline Name	From	To	Length (km)	Nominal Diameter (mm)	Material	Capacity * (Mℓ/day)	Age (years)
Kokstad	Golf Course	Kokstad WTP	Golf Course Reservoir	0.535	300	AC	12.22	24*
Kokstad	Bhongweni	Kokstad WTP	Bhongweni Reservoirs	4.33	450	AC	27.49	24*
Kokstad	Prison	Kokstad WTP	Prison	0.9	300	AC	12.22	24*
Kokstad	Shayamoya	Kokstad WTP	Shayamoya Reservoir 1	4.07	200	uPVC	4.07	24*

**Information from Plant Superintendent*

Table 10.9 Pump Details: Kokstad Potable Water Pump Stations

System	Pump Station Name	Pump Status		Pump Description	Supply From	Supply To	Static Head (m)	Duty Head (m)	Duty Capacity (Mℓ/day)	Approx. Age	Approx. Condition
		Duty	Stand by								
Kokstad	Shaya moya PS WTP	2	1	SPP Unistream 100/26	Kokstad WTP	Shayamoya Res 1	25*	TBD	0.75*	24**	Fair
Kokstad	Shaya moya PS Res 1	2*	1	KSB ETA 50-200	Shayamoya Res 1	Shayamoya Res 2	48*	55*	0.75*	24**	Fair

*Values from Google Earth and informed estimates **From Asset Register

Table 10.10 Reservoir Details: Kokstad System

System	Reservoir Site	Reservoir Name	Capacity (Mℓ)	Reservoir Function	TWL (mASL)	FL (mASL) Approx.
Kokstad WTP	Kokstad WTP	Galaxy Tank: Ext 7	0.3	Terminal	1402.0	1399.22
Kokstad WTP	Kokstad WTP	Main Reservoir	4.5	Bulk	1388.50	1384.67
Kokstad WTP	Kokstad WTP	Prison Reservoir	5	Terminal	1386.0	1381.75
Kokstad WTP	Kokstad WTP	Shayamoya Reservoir	5	Bulk	1388.50	1383.75
Kokstad WTP	Shayamoya	Shayamoya LL Reservoir	1.5	Terminal	1369.0	1363.05
Kokstad WTP	Shayamoya	Shayamoya HL Reservoir	0.75	Terminal	1411.35	1406.66
Kokstad WTP	Bhongweni	Bhongweni Reservoir 1	2	Terminal	1343.0	1339.63*
Kokstad WTP	Bhongweni	Bhongweni Reservoir 2	1.5	Terminal	1343.0	1339.34*
Kokstad WTP	Golf Course	Golf Course Reservoir	1.35	Terminal	1385.0	1381.63*
Kokstad WTP	CBD	Grenswag Reservoir	1.35	Terminal	1352.0	1349.66*

*Values from Google Earth and assumed

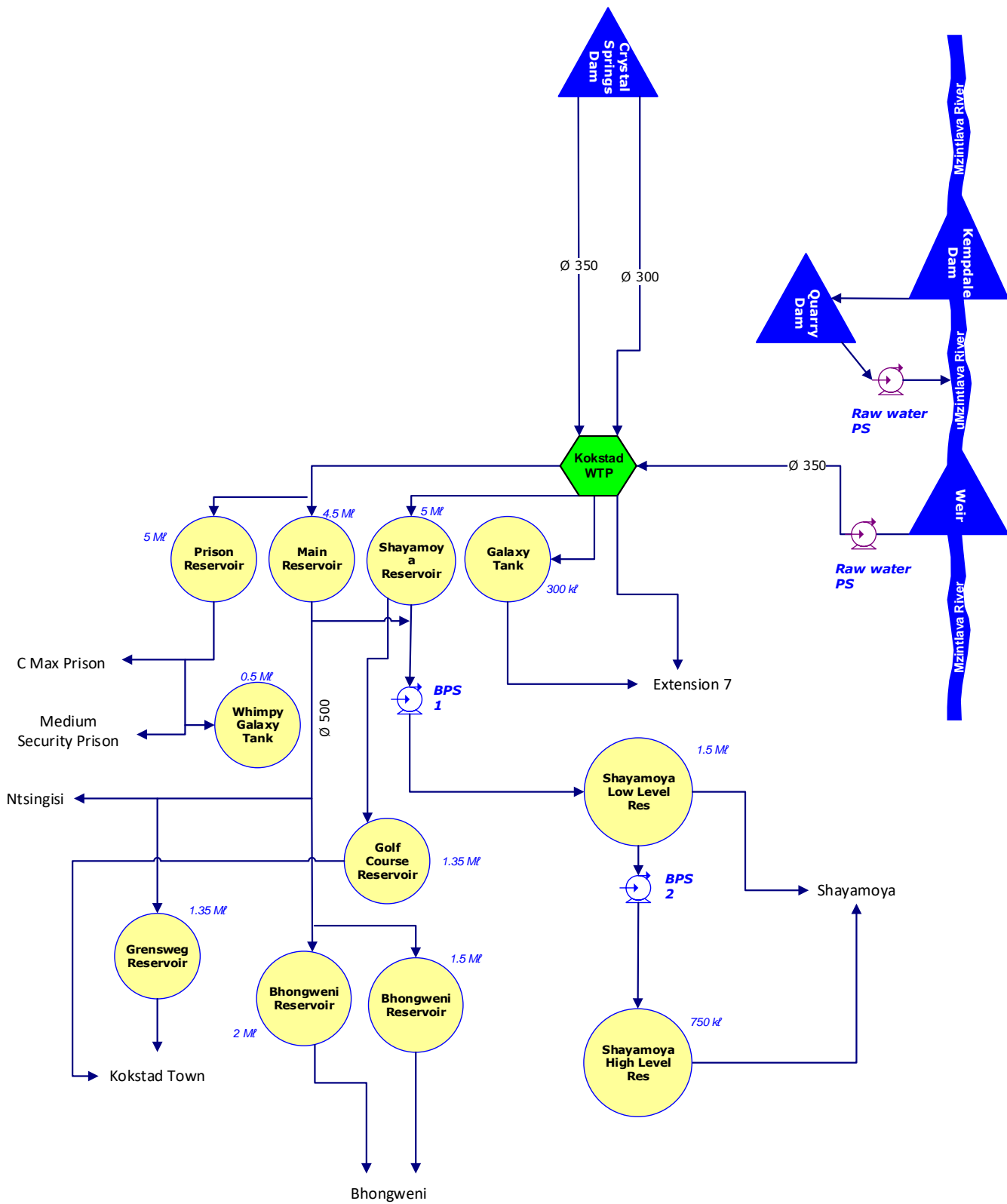

Figure 10.10 Schematic of Kokstad BWSS

10.3.2 Status Quo and Limitations of the Kokstad System

At present, the raw water supply to the Kokstad WTP is approximately 550m³/hour which translates to approximately 13.2 Mℓ/day. The approximate output volume from the plant is 12Mℓ. These figures are questionable as this translated to high water losses within the plant and hence may be attributed to the non-calibration of the meters in the system. The exact volumes, therefore, cannot be determined.

The raw water supply system from Crystal Springs Dam is problematic. The 350mm diameter pipeline supplying water under gravity has frequent bursts. The operator has noticed that the line has more failures when the control valve limits the inflow from this pipe to favour the flow from the pumping line from the river. This closure of the line may be responsible for the constant breaks. The 300mm diameter pipeline does have a few failures in a year but these are not as frequent.

The pumping main experiences frequent breaks. The AC pipeline fails as a result of its' age and the above ground steel pipeline leaks as a result of damage (vandals or general fires) on the coatings and rubber seals. Harry Gwala DM had laid a 300mm diameter raw water pumping main from the existing pump station at the Mzintlava River. This pipeline is only 2.5km long, however, and does not reach the WTP. The pipeline is not connected to the system and is incomplete.

All meters at the WTP should be checked and calibration. The pulsators are non-operational and require maintenance. A new chlorine room is being constructed and this will have to be completed before becoming functional. The servicing of pumps and blowers are done on a reactive basis and no formal maintenance plan is in place.

The potable water system seems to be functional although the age of the infrastructure is also unknown. The level indicators on the reservoirs are not functional and should be maintained.

The projected demand for the system in 2050 is 21 Mℓ/day with the WTP nearing capacity in 2035. To address the current and future water resources requirements, the DM has appointed a contractor to undertake the raising of the existing Kemptdale Dam wall from 4 m to 7.8 m, which will provide an additional yield. The new yield will be sufficient to meet the projected 2030 demand of 14.5 Mℓ/day (DWS, 2024). In addition, the project includes the construction of a new raw water pump station at the Mzintlava River, downstream of Kemptdale Dam, and water abstracted there will be treated at the existing Kokstad WTP. WC/WDM initiatives should be investigated as a means of reducing the demand on the system and this could then delay the need for an additional resource.

10.4 Water Balance/Availability

The existing Kokstad System has infrastructure capacity constraints when water is pumped from Kemptdale Dam at a maximum flow of 0.085 m³/s. With the balance of the demand supplemented by Crystal Springs Dam the system has a total yield of 4.8 Million m³ per annum (13.2 Mℓ/day) at the 98% assurance of supply. The Kokstad System's current water demand is 13.4 Mℓ/day

(4.8 million m³/annum) and is in balance with the system yield when operated optimally (DWS, 2023). The pipeline from Kemptdale Dam could be augmented with a second pipeline to increase supply to 0.17 m³/s and this would increase the system yield to 7.4 million m³/annum (20.3 Mℓ/day) at a 98% assurance level.

10.5 Recommendations for the Mzintlava System

10.5.1 System Components

The following is proposed for the Kokstad Water Supply System:

- An alternate source for the supply to the town should be investigated and a pre and detailed feasibility study conducted to assess options. The UAP Phase 2 and 3 proposes a dam on the Mzintlava River that could possibly yield 30Mℓ/d to supply the growing demand in the area. Further investigative reports are needed.
- Kemptdale Dam Hydrographic and Spillway surveys were undertaken (as per recent engagement with HGDM). The DM are currently raising the wall by 4m. A dam safety investigation should also be conducted to determine the shear strength of the existing wall as there is high sediment loading.
- A detailed hydraulic investigation should be undertaken on the raw water supplies from both supply sources.
- Losses within the water treatment plant must be reduced. Meters, monitoring the inflow and outflow from the works, should be checked and replaced if need be to ensure accurate readings are kept. A full water balance should be conducted each day to establish the total supply to each zone within the town.
- Calibration and possible replacement of meters within the system should be implemented.
- Maintenance on the pulsator clarifiers should be undertaken to make these units fully functional.
- No. 6 filter should be repaired.
- The manifold for the chlorination should be re-installed.
- A maintenance plan and schedule should be implemented for all infrastructure in the system.

REFERENCES

Department of Water Affairs and Forestry. 2008. *KwaZulu-Natal Groundwater Plan, Version 2*. Pretoria: DWAF.

Department of Water and Sanitation (DWS), South Africa. 2017. *Determination of Water Resource Classes and Resource Quality Objectives for Water Resources in the Mzimvubu Catchment. Status Quo and (RU and IUA) Delineation Report*. Compiled by Rivers for Africa eFlows Consulting (Pty) Ltd. for Scherman Colloty and Associates cc. Report no. WE/WMA7/00/CON/CLA/0316. Pretoria: DWS.

Ezemvelo-KZN Wildlife. 2013. *Mount Currie Nature Reserve Protect Area Management Plan 2013*. Pietermaritzburg: EKZNW.

Greater Kokstad Municipality. 2003. *Crystal Springs Dam Safety Inspection*

DWS. 2016. *Development of Operating Rules for Water Supply and Drought Management for Stand-Alone Dams and Schemes: Eastern Cluster - Phase 2 – ANNUAL OPERATING ANALYSIS FOR KOKSTAD WATER SUPPLY SCHEME*

An Update of The Water Reconciliation Strategy Options For The Schemes In The Mkomazi River Catchment Harry Gwala District Municipality Final 29 September 2016. Prepared by: Tlou Consulting (Pty) Ltd, PO Box 1309, PRETORIA, 0001

uMngeni-uThukela Water. 2016. *Universal Access Plan Phase 2 – Progressive Development of a Regional Concept Plan for the Harry Gwala District Municipality*. Prepared by Hatch Consulting (Pty) Ltd in Association with JTN Consulting for uMngeni-uThukela Water. Contract No. 2015/178. uMngeni-uThukela Water: Pietermaritzburg.

DWS. 2011. *Determination of water resource classes and resource quality objectives for the water resources in the Mzimvubu catchment* .

Department of Water Affairs and Forestry (DWAF), South Africa. 2009. *DWAF Water Resource Study in Support of the AsgiSA-EC Mzimvubu Development Project*. Prepared by BKS (Pty) Ltd. For: DWAF Directorate: National Water Resources Planning. Report No: P WMA 12/000/00/3609, Pretoria, South Africa.

Department of Water and Sanitation (DWS), South Africa. 2017. *Determination of Water Resource Classes and Resource Quality Objectives for Water Resources in the Mzimvubu Catchment. River Desktop EWR and Modelling Report: Volume 1 – Systems Modelling*. Compiled by WRP Consulting Engineers (Pty) Ltd. For: Scherman Colloty and Associates cc. Report No: WE/WMA7/00/CON/CLA/0217.

ACKNOWLEDGEMENTS

uMngeni-uThukela Water's comprehensive 2023 Infrastructure Master Plan has been updated and improved to produce this 2024 version. The concerted effort of the Planning Services Department as a whole in producing this document is acknowledged and appreciated. Specific contributions by the various team members deserves acknowledgement:

- Alka Ramnath (Planner) Project management, Section 2, Spatial information, Research and input to all volumes
- Graham Metcalf (Geohydrologist) Groundwater and Wastewater
- Gavin Subramanian (Planning Engineer) Infrastructure on the North Coast System
- Angus Nicoll (Planning Engineer) Infrastructure on the South Coast and uMngeni Central Systems
- Vernon Perumal (Planning Engineer) Infrastructure on the uMkhomazi, Upper uMzintlava, Upper uMzimkhulu and the uMhlathuze and Middle uThukela Systems and compiling the Energy Section
- Mark Scott (Planning Engineer) Infrastructure on the uMngeni Inland, uMfolozi, uMkhuze, uPhongolo and Lake Sibiya Systems
- Nathaniel Padayachee (Planning Engineer) Infrastructure on the Upper uThukela and Buffalo Systems
- Ntuthuko Ngcamu (Head – Water Demand Management Unit) with support from Siphokazi Mabaso, Mathews Nokhanga and Dillon Jacks Water Demand Management Section
- Sakhile Hlalukane (Hydrologist) Water resources of the North Coast, South Coast and Upper uThukela Systems
- Sandile Sithole (Hydrologist) Water resources of all systems excluding the North Coast, South Coast and Upper uThukela Systems
- Mlungisi Shabalala (Hydrologist) Water resources of the Middle uThukela, uMhlathuze, uMfolozi, uMkhuze, uPhongolo and Lake Sibiya Systems
- Sithembile Mbonambi (Planning Analyst) Water resources of the uMkhomazi, Upper uMzintlava and Upper uMzimkhulu Systems

The 2024 Infrastructure Master Plan was not completed by the abovementioned people without the valued assistance of numerous other persons and parties. Their contributions are gratefully acknowledged. These include uMngeni-uThukela Water and WSA Operations Staff, uMngeni-uThukela Water's Water and Environment Department (water quality) and uMngeni-uThukela Water's Process Services Department (process and treatment details for UUW plants and others).

Kevin Meier,
MANAGER: PLANNING SERVICES